

PRODUCT  
CATALOG

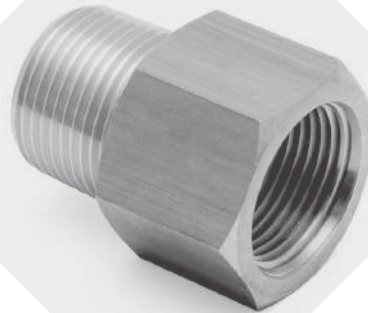

**adaptall**

INTERNATIONAL ADAPTER & FITTING SOLUTIONS

# THREAD SPECIFICATION CHARTS

## BSPP Thread Specification Chart

Dash Size	Thread Size	Threads per inch (TPI)	Male Thread O.D (mm)	Male Thread O.D (inches)	Female Thread I.D (mm)	Female Thread I.D (inches)
02	1/8	28	9.6	0.38	8.6	0.34
04	1/4	19	13	0.51	11.9	0.47
06	3/8	19	16.5	0.65	15.2	0.6
08	1/2	14	20.8	0.82	19.1	0.75
10	5/8	14	22.8	0.9	20.8	0.82
12	3/4	14	26.3	1.04	24.6	0.97
16	1	11	33.1	1.3	30.7	1.21
20	1-1/4	11	41.8	1.64	39.4	1.55
24	1-1/2	11	47.7	1.88	45.5	1.79
32	2	11	59.5	2.34	57.4	2.26
40	2-1/2	11	75.1	2.95	72.6	2.86
48	3	11	87.9	3.46	85.4	3.36

## BSPT Thread Specification Chart

Thread Size	Threads per inch (TPI)	Male Thread O.D (mm)	Male Thread O.D (inches)	Female Thread I.D (mm)	Female Thread I.D (inches)
1/8	28	9.6	0.38	8.6	0.339
1/4	19	13.1	0.516	11.2	0.441
3/8	19	16.6	0.654	14.7	0.579
1/2	14	20.9	0.823	18.3	0.720
5/8	14	22.9	0.902	20.6	0.811
3/4	14	26.4	1.039	23.9	0.941
1	11	33.2	1.307	29.7	1.169
1-1/4	11	41.9	1.65	38.6	1.520
1-1/2	11	47.8	1.882	44.5	1.752
2	11	59.6	2.346	56.4	2.220
2-1/2	11	75.2	2.961	71.9	2.831
3	11	87.8	3.457	84.6	3.331

## Metric Thread Specification Chart

Thread Callout	Thread Pitch (mm)	Male Thread O.D (mm)	Male Thread O.D (inches)	Female Thread I.D (mm)	Female Thread I.D (inches)
M8 X 1.0	1.0	8.0	0.315	6.9	0.272
M10 X 1.0	1.0	10.0	0.394	8.9	0.35
M10X1.5	1.5	10.0	0.394	8.4	0.331
M12X1.0	1.0	12.0	0.472	10.9	0.429
M12 X 1.5	1.5	12.0	0.472	10.4	0.409
M14 X 1.5	1.5	14.0	0.551	12.4	0.488
M16 X 1.5	1.5	16.0	0.63	14.4	0.567
M18 X 1.5	1.5	18.0	0.709	16.4	0.646
M20 X 1.5	1.5	20.0	0.787	18.4	0.724
M22 X 1.5	1.5	22.0	0.866	20.4	0.803
M24 X 1.5	1.5	24.0	0.945	22.4	0.882
M26 X 1.5	1.5	26.0	1.024	24.4	0.961
M27 X 2.0	2.0	27.0	1.063	24.8	0.976
M30 X 2.0	2.0	30.0	1.181	27.8	1.094
M33 X 2.0	2.0	33.0	1.299	30.8	1.213
M36 X 2.0	2.0	36.0	1.417	33.8	1.331
M42 X 2.0	2.0	42.0	1.654	39.8	1.567
M45 X 2.0	2.0	45.0	1.772	42.8	1.685
M48 X 2.0	2.0	48.0	1.89	45.8	1.803
M52 X 2.0	2.0	52.0	2.047	49.8	1.961
M60 X 2.0	2.0	60.0	2.362	57.8	2.276

## 24° DIN Tube - Thread Callout & Compatibility Chart

Tube Series	Tube O.D	Metric Thread Callout	Tube Nut Part #	Cutting Ring Part #	Tube Plug Part #	Tube Cap Part #
LL Extra Light Duty	4 mm	8 mm x 1.0	5201LL-04	5202LL-04	-	-
	6 mm	10 mm x 1.0	5201LL-06	5202LL-06	-	-
	8 mm	12 mm x 1.0	5201LL-08	5202LL-08	-	-
	10 mm	14 mm x 1.0	5201LL-10	5202LL-10	-	-
	12 mm	16 mm x 1.0	5201LL-12	5202LL-12	-	-
L Light Duty	6 mm	12 mm x 1.5	5201L-06	5202-06	5203L-06	5204L-06
	8 mm	14 mm x 1.5	5201L-08	5202-08	5203L-08	5204L-08
	10 mm	16 mm x 1.5	5201L-10	5202-10	5203L-10	5204L-10
	12 mm	18 mm x 1.5	5201L-12	5202-12	5203L-12	5204L-12
	15 mm	22 mm x 1.5	5201L-15	5202-15	5203L-15	5204L-15
	18 mm	26 mm x 1.5	5201L-18	5202-18	5203L-18	5204L-18
	22 mm	30 mm x 2.0	5201L-22	5202-22	5203L-22	5204L-22
	28 mm	36 mm x 2.0	5201L-28	5202-28	5203L-28	5204L-28
	35 mm	45 mm x 2.0	5201L-35	5202-35	5203L-35	5204L-35
	32 mm	52 mm x 2.0	5201L-42	5202-42	5203L-42	5204L-42
S Heavy Duty	6 mm	14 mm x 1.5	5201S-06	5202-06	5203S-06	5204S-06
	8 mm	16 mm x 1.5	5201S-08	5202-08	5203S-08	5204S-08
	10 mm	18 mm x 1.5	5201S-10	5202-10	5203S-10	5204S-10
	12 mm	20 mm x 1.5	5201S-12	5202-12	5203S-12	5204S-12
	14 mm	22 mm x 1.5	5201S-14	5202-14	5203S-14	5204S-14
	16 mm	24 mm x 1.5	5201S-16	5202-16	5203S-16	5204S-16
	20 mm	30 mm x 2.0	5201S-20	5202-20	5203S-20	5204S-20
	25 mm	36 mm x 2.0	5201S-25	5202-25	5203S-25	5204S-25
	30 mm	42 mm x 2.0	5201S-30	5202-30	5203S-30	5204S-30
	38 mm	52 mm x 2.0	5201S-38	5202-38	5203S-38	5204S-38

## TECHNICAL

TERMS AND DEFINITIONS.....	4
SEALING METHODS & TECHNOLOGIES.....	6
HOW TO ID BRITISH THREADS & FITTINGS .....	10
HOW TO ID METRIC THREADS & FITTINGS.....	12
HOW TO INSTALL FITTINGS & ADAPTERS.....	17

## PRODUCTS

### FEATURED

FITTING GAUGES.....	23
KITS .....	24
STOCKING PROGRAMS .....	26

### STEEL

BANJO FITTINGS.....	27
DIN TUBE FITTINGS .....	29
INTERNATIONAL ADAPTERS .....	42

### STAINLESS STEEL

DIN TUBE FITTINGS .....	74
INTERNATIONAL ADAPTERS .....	79

### BRASS

COMPRESSION, POLYTUBE & PUSH TO CONNECT.....	85
FITTINGS & ADAPTERS .....	88

### MALLEABLE IRON

BSP PIPE FITTINGS.....	92
------------------------	----

## ABOUT

COMPLIANCES.....	94
FITTING & PLATING STANDARDS .....	94
MATERIAL SPECS .....	94
WARRANTY, TERMS & CONDITIONS .....	94

# TECHNICAL TERMS & DEFINITIONS

## Metric Fittings vs. Metric Threads

The terminology used to describe the majority of foreign threaded fittings can be confusing to some. Metric fitting is a loose term describing fitting bodies with foreign threads including BSP, DIN, JIS, Kobelco, Komatsu, and Metric, even though some of these are based in imperial or "inch" dimensions. Metric threads, however, refers to a specific type of foreign thread.

## Part Numbering and Hose/Tube Side vs. Port Side

When fittings are classified or part-numbers displayed, the first group of numbers indicates the part series or group, while the dash sizes indicate the thread sizes. The sizes are usually displayed tube or hose side first, meaning that the end connecting to a hose or tube is typically listed as the first dash size. The port side is usually listed as the second dash size.

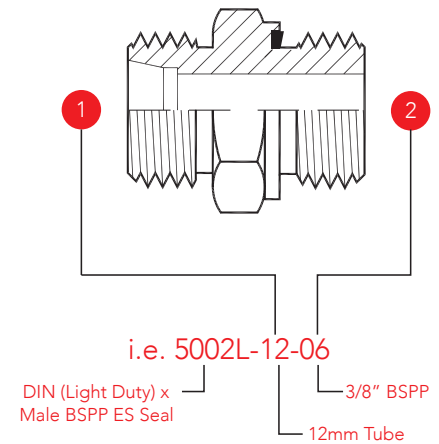

## Thread Form vs. Thread Pitch vs Threads per Inch

When identifying fittings, another important factor to look at is thread form and thread pitch, or threads per inch in other cases. Thread form refers to the angle (in degrees) that exists between adjacent flanks of a thread. This is a difficult method of identification and requires a profile projector to be certain. Thread pitch however, refers to the distance measured between adjacent thread crests, and is much easier to identify.

Sometimes threads per inch or "TPI" is used, which counts the number of threads over one inch of distance. In some cases, calculations are required i.e. 5.5 threads counted over a 1/2" would mean there are 11 threads over 1". It is recommended to use a thread gauge as it provides the most accurate form of identification.

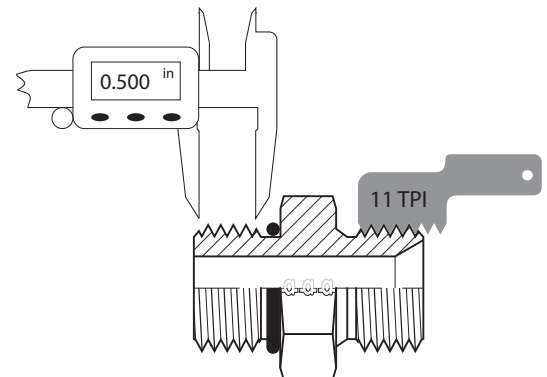
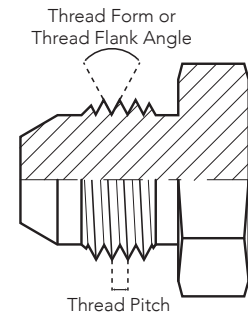

## Major vs Minor Thread Diameter

All threads have what's known as a Major Diameter, and a Minor Diameter. Major Diameter is the measurement from thread crest to thread crest, while Minor Diameter is measured from thread root to thread root. With male threads, the Major Diameter (our outer diameter, O.D for short) of the thread could be measured and compared to a chart of various thread types and known Major Diameters/O.D's for identification purposes. For female threads, instead compare the Minor Diameter (also known as internal diameter, or I.D for short). You can compare your caliper readings to published specifications in order to find the closest match.

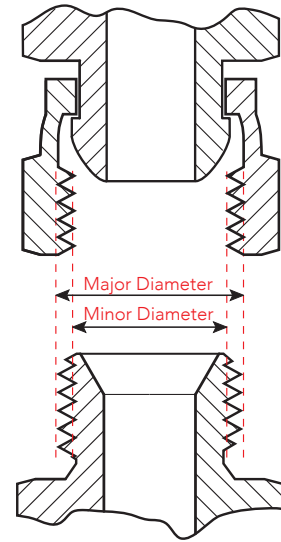

# TECHNICAL SEALING METHODS

## Port Fittings - Tapered vs. Parallel Threads

If dealing with a port fitting, a good first step towards thread identification is to determine whether the thread is parallel or tapered. Parallel means the thread walls are straight; while tapered means the thread walls, if continued lengthwise, would eventually meet. A seal must be used for all parallel fittings in port application, with the exception of Cutting Face fittings, however these are rarely used. It is important to note that BSPT (British Standard Pipe – Tapered) can seal into a parallel BSP port, and Metric Tapered threads are capable of sealing into a parallel Metric port.

This first step will help you eliminate a number of possible thread types, as well as possibly explain the method of sealing. For a parallel thread in port application, the fitting will usually seal at the top of the thread by means of an O-ring or seal. With a tapered thread, the fitting typically seals via metal-to-metal wedging of the threads. Sometimes a thread sealant is applied prior to installation to reduce instances of leakage on tapered threads.

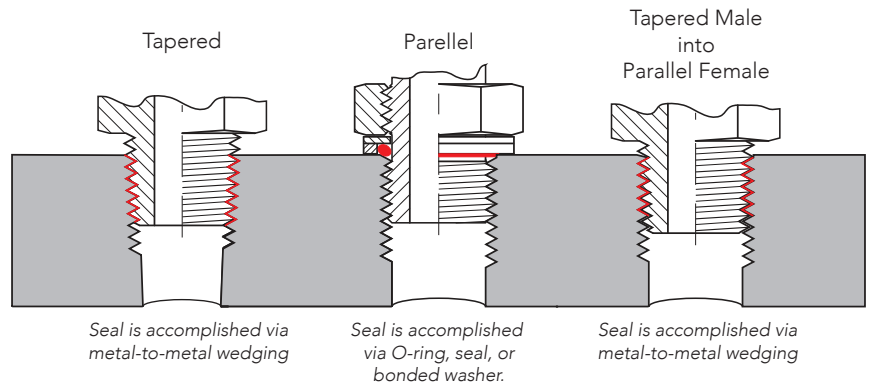

<b>Tapered Male X Tapered Female</b> Seals via thread wedging	<b>Parallel Male X Parallel Female</b> Seals via O-ring/Bonded Seal	<b>Tapered Male X Parallel Female</b> Seals via thread wedging
BSPT	BSPP	M-BSPT X F-BSPP (port/fixed female only)
Metric Taper	Metric	M-Metric Taper X F-Metric (port/fixed female only)
NPT	SAE O-ring Boss	

## Flared Seat vs Cone Seat vs Ball Seat

The ability to properly identify seats, chamfers, and their corresponding angles can also be a benefit to overall fitting identification. Flared seats refer to the protruding “nose cone” on a male thread, but also the corresponding inverted flare in a female thread. Chamfer is a term assigned to the internally bevelled sealing surface inside of a male thread, which mates with a female cone seat and is typically angled at 30°/60°. Please note the language is interchangeable i.e. Chamfers can also be referred to as Inverted Flared Seats and vice versa.

Ball seats however refer to the spherical sealing surface inside a female thread (swivel only) that seals with the chamfer on the inside of a male thread. These sealing systems all share a common trait in that there is a metal-to-metal seal created where the male and female surfaces contact (not including the threads).

Flared Seat	Cone Seat	Ball Seat
JIC	BSPP	Metric (female swivel)
JIS	NPT (NPSM female swivel)	NPSM (brass ball seat)
Komatsu	DIN DKO Metric	
GB 37/74 Metric		

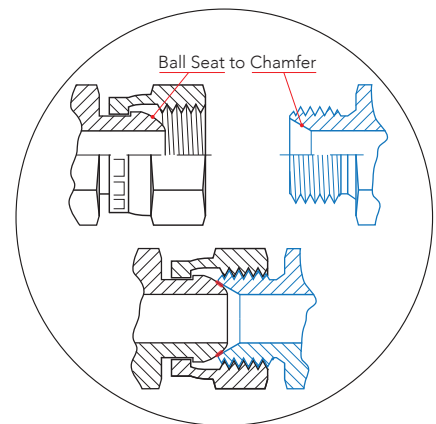
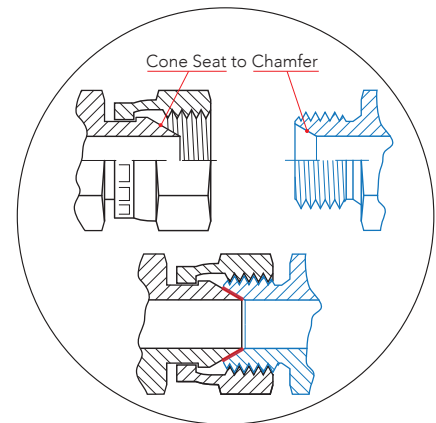
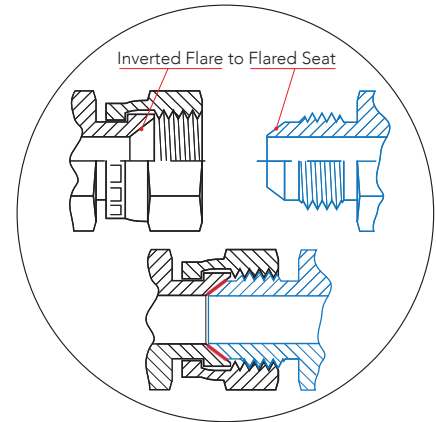

# TECHNICAL SEALING METHODS

## Face Seal vs Boss Seal

Both Face Sealing and Boss Sealing fitting types utilize an encapsulated O-ring in order to create a seal. The difference is that Face Seal fittings have the O-ring located in the grooved area at the end of the male thread, while Boss Seal fittings have the O-ring located at the base of the male thread. The corresponding female Face Seal fitting has a flat sealing surface that engages the O-ring in the male fitting and compresses it as the fittings are threaded together and creates a seal. Boss Seal female fittings on the other hand have a grooved "boss" before the first thread that acts to encapsulate the O-ring on the male thread thereby creating a seal.

The most popular Face Seal fitting type is O-ring Face Seal/Seal-Lok™ however this can be easily confused with HIAB fittings which also utilize Face Sealing. The most popular Boss Seal fitting type is O-ring Boss, however this can be easily confused with Metric ISO 6141 which utilizes Metric threads and a Boss Seal.

Face Seal Fitting Types	Boss Seal Fitting Types
O-ring Face Seal	SAE O-ring Boss
HIAB	Metric ISO 6141
Chinese Flat Face Metric	

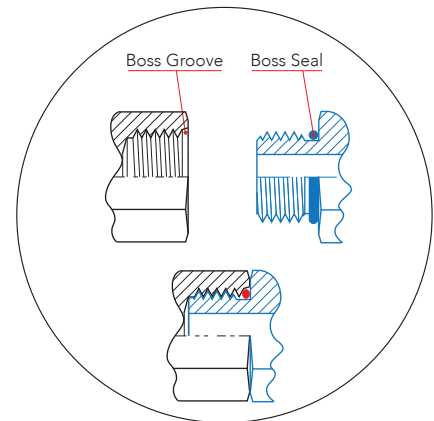
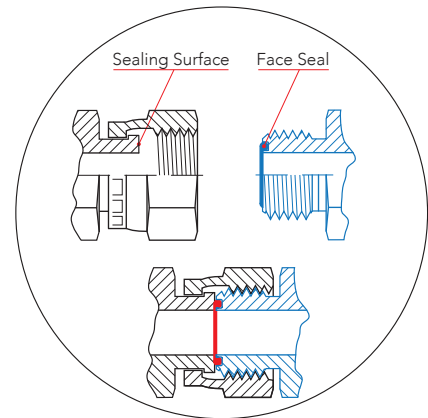

## Metal to Metal Sealing

One of the rarer methods of sealing a fitting in port is Metal to Metal Sealing, also known as Cutting Face or Type B. This design creates a seal by means of a sharp "cutting face" at the base of the male thread that cuts into the flats or "spotface" surrounding the port when the fitting is threaded and tightened.

Cutting Face Type B is available in BSPP (ISO 1179-4) and Metric (ISO 9974- 3), although it is commonly mis-identified as regular BSPP or Metric port fitting with the seal missing. Look for a raised outer section on the male fitting where the bonded washer or seal would go; if it exists this indicates the fitting is Cutting Face.

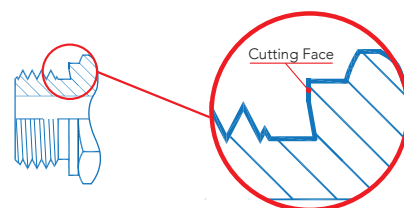
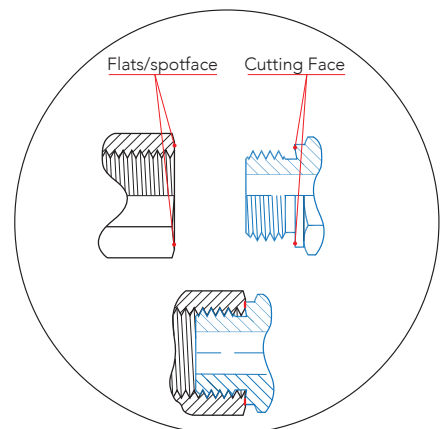



# TECHNICAL SEALING METHODS

## 24° DIN Tube Fittings

DIN fittings have a 24° tapered throat angle that exists inside the male threads. To achieve a tube connection, a tube nut is tightened over the metric threads (hardened pre-assembly fitting bodies are recommended for installation) forcing a ferrule or cutting ring to grip the tube. By having the nut securely fastened to the tube fitting, both compress the cutting ring which holds the assembly in place and creates a seal. This sealing style also includes Kobelco fittings which are essentially an L-series Metric thread with a 1.5mm thread pitch in all sizes.

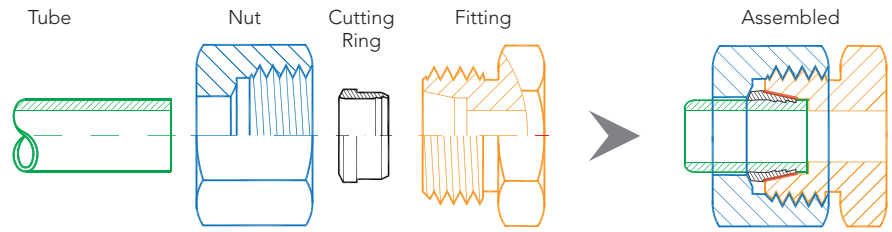

24° fittings and accessories belong to one of three **Pressure Classes**: LL series for low pressure, L series for medium pressure, and S series for high pressure applications. These are also referred to as Light Duty, Heavy Duty, etc.

24° Metric Compression Fitting Types
DIN Tube
Kobelco
Japan Steel Works (JSW)
French GAZ

## Sealing Surface Angles

The angle sealing surfaces on fittings can be used to aid in fitting identification. There are a few ways to identify this angle, such as by means of angle gauge or by profile projector.

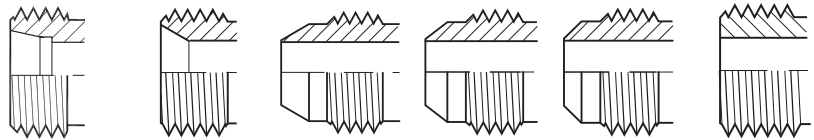

24° Internal Chamfer	30° Internal Chamfer	30° External Flare	37° External Flare	45° External Flare	None/Flat
DIN Metric	BSPP	Komatsu	JIC	SAE 45°	ORFS
Kobelco	DIN 7631 Metric	JIS	GB Metric (Chinese)		ORB
JSW	NPTF/NPSM				ISO 6149 Metric
French GAZ					BSPP & Metric Port
					Chinese Flat Face Metric

# TECHNICAL HOW TO ID BRITISH THREADS & FITTINGS

British Pipe Standard fittings are amongst the most popular of all foreign threads in the world today. These threads come in two versions: parallel (BSPP), and tapered (BSPT). The thread flank angle for both tapered and parallel British threads is 55°. Although BSP is a foreign thread, it isn't actually metric. This is why it comes in Imperial sizes: 1/8, 1/4, 1/2, 3/4, etc.

BSP parallel (BSPP) threads commonly seal via a 30° chamfer on the male thread to a 30° recessed cone seat inside the female thread (swivel only). If it is a port application, an O-ring and washer, Elastomeric seal or a bonded washer are needed to achieve a proper seal for parallel threads. For tapered BSP threads (BSPT), a seal is accomplished via thread wedging with additional support from thread dope or tape. As previously mentioned, it is possible for a male BSPT (tapered) to thread into a female BSPP (parallel), so long as the female thread is fixed and not swivel (this is because of the recessed cone seat). To identify a BSPP fitting complete the following steps:

- 1) Confirm the thread is parallel and not tapered
- 2) Determine the threads per inch (TPI) count
- 3) Determine the thread O.D (male thread) or I.D (female thread)
- 4) Find a match on the chart below by combining your O.D or I.D measurement with the TPI you measured.
- 5) If an angled sealing surface exists, use it to identify which specific type of British fitting it is.

Use the diagram to your right to confirm what type of British fitting you have. Use caution as "multi-purpose fittings" exist that accommodate 2 or more sealing styles in one fitting (such as Adaptall's 9005ES series that can be used for BSPP port or swivel connection).

## BSPP Thread Specification Chart

Dash Size	Thread Size	Threads per inch (TPI)	Male Thread O.D (mm)	Male Thread O.D (inches)	Female Thread I.D (mm)	Female Thread I.D (inches)
02	1/8	28	9.6	0.38	8.6	0.34
04	1/4	19	13	0.51	11.9	0.47
06	3/8	19	16.5	0.65	15.2	0.6
08	1/2	14	20.8	0.82	19.1	0.75
10	5/8	14	22.8	0.9	20.8	0.82
12	3/4	14	26.3	1.04	24.6	0.97
16	1	11	33.1	1.3	30.7	1.21
20	1-1/4	11	41.8	1.64	39.4	1.55
24	1-1/2	11	47.7	1.88	45.5	1.79
32	2	11	59.5	2.34	57.4	2.26
40	2-1/2	11	75.1	2.95	72.6	2.86
48	3	11	87.9	3.46	85.4	3.36

## BSPP Threads and Sealing Methods

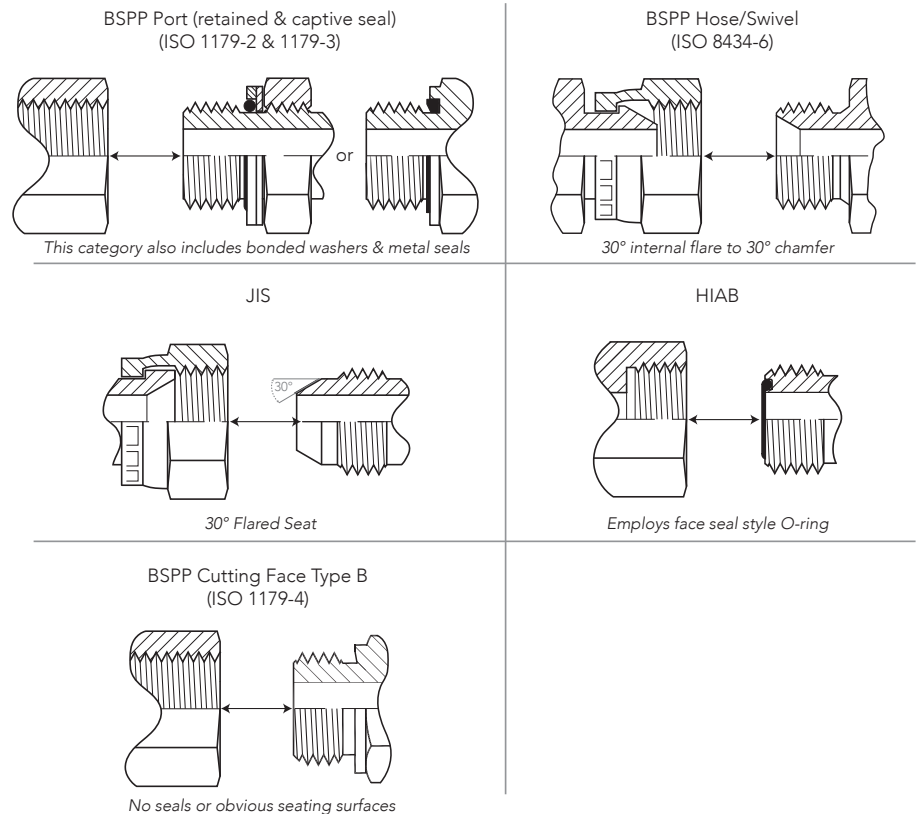

# TECHNICAL HOW TO ID BRITISH THREADS & FITTINGS

## Japanese (JIS) tapered and parallel fittings

Japanese (JIS) tapered and parallel fittings are identical to British standard pipe threads, and are therefore considered to be in the 'British Fitting' group. The only difference is that parallel JIS threads have a 30° cone seat on the male end, and a 30° flared seat on the female ends. JIS tapered threads are identical to BSPT threads. Please refer to the BSPP and BSPT thread charts above for details.

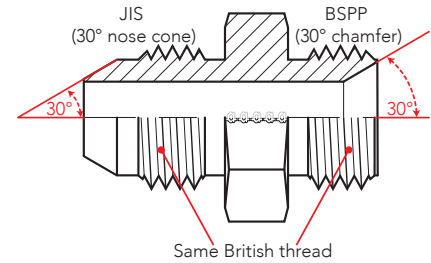

## British tapered threads (BSPT)

For British tapered threads (BSPT) caution should be taken as the most common tapered fitting is NPT. The easiest way to distinguish any tapered fitting type from NPT is to verify if a chamfered sealing surface exists. If it does the fitting is almost certainly NPT. If not, it is either BSPT or Metric Taper (Metric Taper is far less common).

To verify the thread is BSPT, you would undergo the same steps as for a parallel British thread. First, verify the number of threads per inch. Second, measure the O.D. at the 3-4th thread from the end of the fitting. You can cross-reference your measurements to the following chart in order to verify the fitting is BSPT.

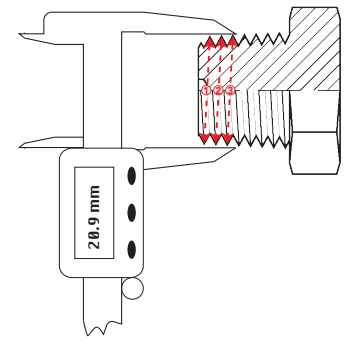

## BSPT Thread Specification Chart

Thread Size	Threads per inch (TPI)	Male Thread O.D (mm)	Male Thread O.D (inches)	Female Thread I.D (mm)	Female Thread I.D (inches)
1/8	28	9.6	0.38	8.6	0.339
1/4	19	13.1	0.516	11.2	0.441
3/8	19	16.6	0.654	14.7	0.579
1/2	14	20.9	0.823	18.3	0.720
5/8	14	22.9	0.902	20.6	0.811
3/4	14	26.4	1.039	23.9	0.941
1	11	33.2	1.307	29.7	1.169
1-1/4	11	41.9	1.65	38.6	1.520
1-1/2	11	47.8	1.882	44.5	1.752
2	11	59.6	2.346	56.4	2.220
2-1/2	11	75.2	2.961	71.9	2.831
3	11	87.8	3.457	84.6	3.331

NOTE: It is a fairly common mistake to identify a BSPT (tapered) as an NPT. Always remember that NPT threads have a 60° thread flank angle, and BSPT has a 55° angle (this can be verified with a thread gauge although caution must be taken). NPT (NPTF) males also typically include a 30° chamfered sealing surface while BSPT do not.

# TECHNICAL HOW TO ID METRIC THREADS & FITTINGS

Metric threads share many characteristics with British threads, so caution must be taken when attempting to differentiate the two. First, if the Metric thread is DIN 7631 it will have a 30° chamfer on the male thread much the same as a BSPP male. For elbows in port application, Metric threads (ISO 9974-1) also mimic BSPP adjustable studs ends with the only difference being the threads. BSPT fittings closely resemble Metric taper fittings, although Metric taper is far less common. There are also variations of the sealing surfaces amongst different Metric fitting types that can create difficulty when attempting to identify.

For regular Metric parallel threads, taking a caliper reading of the threads outer diameter in millimetres (mm) will give a reading of the exact thread size but not the thread pitch. For example, a caliper reading of 12.03mm indicates it is very likely a 12mm thread. We still do not know however if it is 1.0 or 1.5 thread pitch (or some other pitch).

These steps should be taken in order to ensure you have successfully identified the proper Metric thread:

1. Identify if the thread is parallel or tapered
2. Determine the thread pitch in mm (typically 1.0, 1.5, or 2.0, but other sizes do exist)
3. Determine the thread O.D (male thread) or I.D (female thread)
4. Find the closest match on the chart below (thread O.D and pitch combine into a "thread callout" such as M12 x 1.5 indicating a 12mm O.D with 1.5mm pitch)
5. If an angled sealing surface exists, use it to identify which specific type of Metric fitting it is.

**Metric Thread Specification Chart**

Thread Callout	Thread Pitch (mm)	Male Thread O.D (mm)	Male Thread O.D (inches)	Female Thread I.D (mm)	Female Thread I.D (inches)
M8 X 1.0	1.0	8.0	0.315	6.9	0.272
M10 X 1.0	1.0	10.0	0.394	8.9	0.35
M10X1.5	1.5	10.0	0.394	8.4	0.331
M12X1.0	1.0	12.0	0.472	10.9	0.429
M12 X 1.5	1.5	12.0	0.472	10.4	0.409
M14 X 1.5	1.5	14.0	0.551	12.4	0.488
M16 X 1.5	1.5	16.0	0.63	14.4	0.567
M18 X 1.5	1.5	18.0	0.709	16.4	0.646
M20 X 1.5	1.5	20.0	0.787	18.4	0.724
M22 X 1.5	1.5	22.0	0.866	20.4	0.803
M24 X 1.5	1.5	24.0	0.945	22.4	0.882
M26 X 1.5	1.5	26.0	1.024	24.4	0.961
M27 X 2.0	2.0	27.0	1.063	24.8	0.976
M30 X 2.0	2.0	30.0	1.181	27.8	1.094
M33 X 2.0	2.0	33.0	1.299	30.8	1.213
M36 X 2.0	2.0	36.0	1.417	33.8	1.331
M42 X 2.0	2.0	42.0	1.654	39.8	1.567
M45 X 2.0	2.0	45.0	1.772	42.8	1.685
M48 X 2.0	2.0	48.0	1.89	45.8	1.803
M52 X 2.0	2.0	52.0	2.047	49.8	1.961
M60 X 2.0	2.0	60.0	2.362	57.8	2.276

# TECHNICAL HOW TO ID METRIC THREADS & FITTINGS

If you have properly identified this as a Metric thread you still need to determine what version or style of Metric Fitting this is.

## Metric Threads and Methods of Sealing

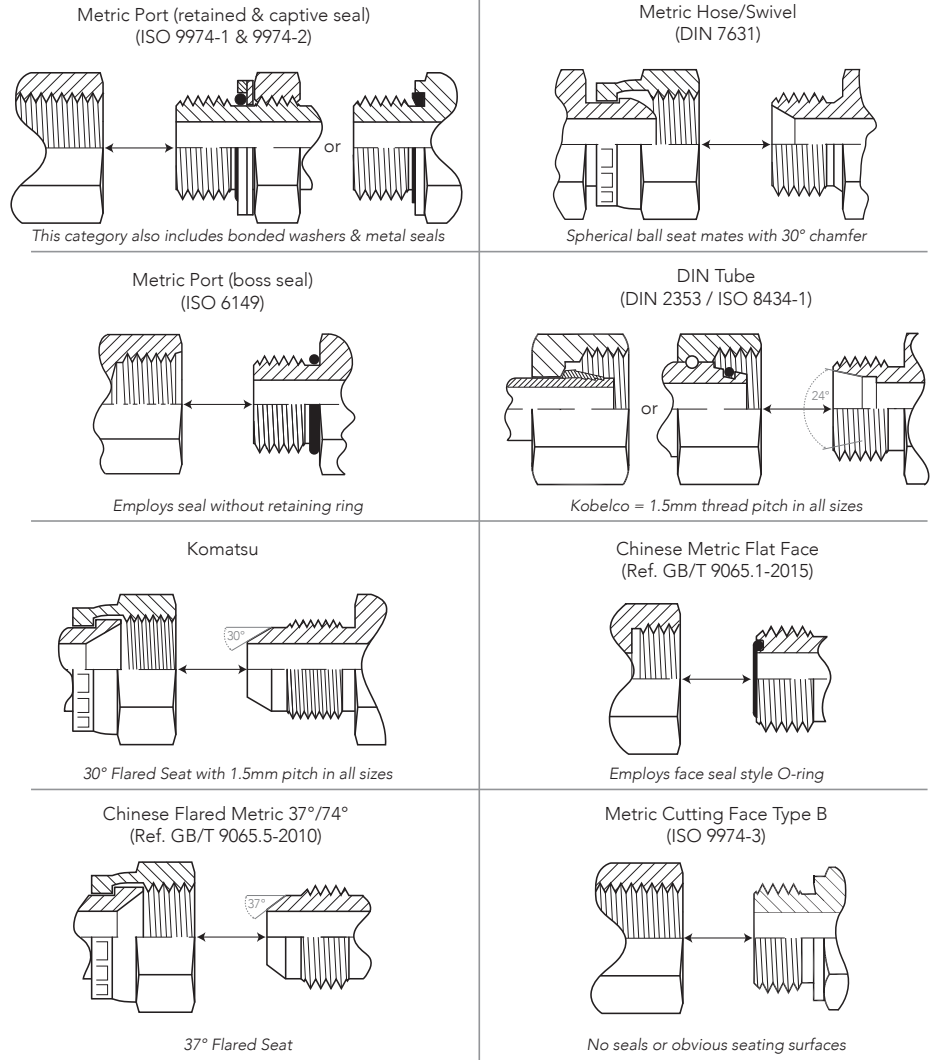

# TECHNICAL HOW TO ID METRIC THREADS & FITTINGS

## DIN Tube Fittings

As previously mentioned, DIN tube fittings have a 24° tapered throat on the inside of the male fitting which should clearly identify it as being DIN if a Metric thread has also been identified. To identify which series and tube size the fitting belongs to, examine the tube nut itself. Most manufacturers indicate the tube series and size on the nut itself. The system used for this marking combines TUBE SERIES with TUBE O.D, for example 15mm tube in the L series is shortened to L15.

If the series and size is not listed on the part, match the tube O.D with the metric thread callout (thread size and thread pitch in mm) on the chart provided to find the corresponding tube series and size:

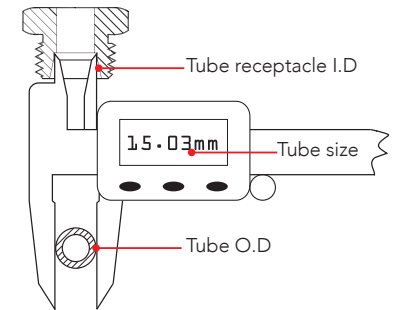
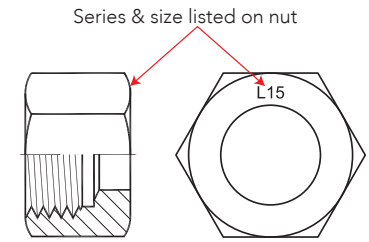

## DIN Tube Extra Light Duty (LL), Light Duty (L) & Heavy Duty (S) Component Compatibility Chart

Tube Series	Tube O.D	Metric Thread Callout	Tube Nut Part #	Cutting Ring Part #	Tube Plug Part #	Tube Cap Part #
LL Extra Light Duty	4 mm	8 mm x 1.0	5201LL-04	5202LL-04	-	-
	6 mm	10 mm x 1.0	5201LL-06	5202LL-06	-	-
	8 mm	12 mm x 1.0	5201LL-08	5202LL-08	-	-
	10 mm	14 mm x 1.0	5201LL-10	5202LL-10	-	-
	12 mm	16 mm x 1.0	5201LL-12	5202LL-12	-	-
L Light Duty	6 mm	12 mm x 1.5	5201L-06	5202-06	5203L-06	5204L-06
	8 mm	14 mm x 1.5	5201L-08	5202-08	5203L-08	5204L-08
	10 mm	16 mm x 1.5	5201L-10	5202-10	5203L-10	5204L-10
	12 mm	18 mm x 1.5	5201L-12	5202-12	5203L-12	5204L-12
	15 mm	22 mm x 1.5	5201L-15	5202-15	5203L-15	5204L-15
	18 mm	26 mm x 1.5	5201L-18	5202-18	5203L-18	5204L-18
	22 mm	30 mm x 2.0	5201L-22	5202-22	5203L-22	5204L-22
	28 mm	36 mm x 2.0	5201L-28	5202-28	5203L-28	5204L-28
	35 mm	45 mm x 2.0	5201L-35	5202-35	5203L-35	5204L-35
	32 mm	52 mm x 2.0	5201L-42	5202-42	5203L-42	5204L-42
S Heavy Duty	6 mm	14 mm x 1.5	5201S-06	5202-06	5203S-06	5204S-06
	8 mm	16 mm x 1.5	5201S-08	5202-08	5203S-08	5204S-08
	10 mm	18 mm x 1.5	5201S-10	5202-10	5203S-10	5204S-10
	12 mm	20 mm x 1.5	5201S-12	5202-12	5203S-12	5204S-12
	14 mm	22 mm x 1.5	5201S-14	5202-14	5203S-14	5204S-14
	16 mm	24 mm x 1.5	5201S-16	5202-16	5203S-16	5204S-16
	20 mm	30 mm x 2.0	5201S-20	5202-20	5203S-20	5204S-20
	25 mm	36 mm x 2.0	5201S-25	5202-25	5203S-25	5204S-25
	30 mm	42 mm x 2.0	5201S-30	5202-30	5203S-30	5204S-30
38 mm	52 mm x 2.0	5201S-38	5202-38	5203S-38	5204S-38	

# TECHNICAL HOW TO ID METRIC THREADS & FITTINGS

## Kobelco Fittings

Kobelco fittings are essentially the same as 24° DIN Metric tube fittings however all sizes of Kobelco threads have a 1.5mm pitch. All tube accessories for Kobelco fittings belong to the L series and are fully interchangeable. However, the only sizes that are truly unique to Kobelco are in the list below.

## Kobelco Component Compatibility Chart

Tube Series	Tube O.D	Metric Thread Callout	Tube Nut Part #	Cutting Ring Part #	Tube Plug Part #	Tube Cap Part #
L	22 mm	30 mm x 1.5	5201L-22-30X1.5	5202-22	9248-22-30	9249-22-30
	28 mm	36 mm x 1.5	5201L-28-36X1.5	5202-28	9248-28-36	9249-28-36
	35 mm	45 mm x 1.5	5201L-35-45X1.5	5202-35	9248-35-45	9249-35-45

## Komatsu Fittings

Komatsu fittings have a 1.5mm thread pitch in all sizes and seals via a 30°/60° cone seat. If you identify a Metric thread with a nose cone be very careful to distinguish if it's actually a 30°/60° (Komatsu) cone seat instead of 37°/74° (GB Chinese) as the latter are becoming more common.

## 37°/74° and Flat Face Chinese Metric Fittings

These fittings are becoming more and more common out of China on heavy equipment using Chinese standards. What defines these standards are that they both utilise North American styles of sealing but with Metric threads. This includes O-ring face seal (Seal-Lok) and 37° flared seat (JIC or Triple-Lok) sealing methods, however the UN or SAE threads are replaced with Metric.

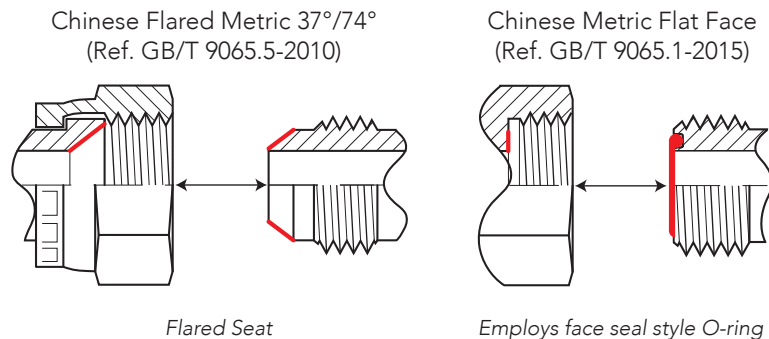

## Metric Taper Threads

If you have a Metric tapered thread, one would undergo the same initial steps for identification of thread pitch as a parallel Metric thread. Also similar to parallel Metric threads is that an O.D measurement will reveal the actual thread size (i.e. 18.01mm measurement means the thread is likely M18). However, to do this accurately with Tapered Metric threads one must measure the O.D at the third row of threads from the end of the fitting.

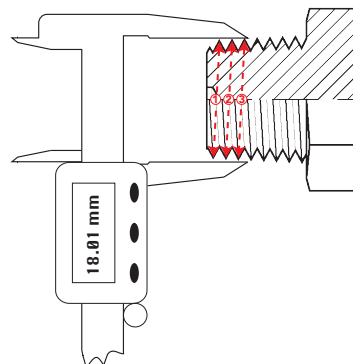

# TECHNICAL HOW TO INSTALL FITTINGS & ADAPTERS

## Installation of Non-Adjustable & Straight Port Fittings

1. Observe unassembled parts, especially threads and bore to ensure it is free of foreign material, burrs, nicks, etc.
2. Make sure compound/material and hardness of O-ring are suitable for the medium type and temperature.
3. Observe O-ring for nicks or cuts and replace if any found. Never use a damaged O-ring!
4. Install O-ring (do not re-use a worn or aged O-ring) on male thread and make sure the O-ring is not cocked or twisted. Abut O-ring to the base of the thread.
5. Lubricate the O-ring with a light coat of the system's fluid or suitable lubricant.
6. Install retaining ring over the O-ring (if included) and ensure O-ring is seated inside the retaining ring evenly.
7. Screw and tighten the fitting or adapter into the port using suggested torque values.
8. Inspect the assembly to ensure the O-ring is properly seated and there are no leaks.

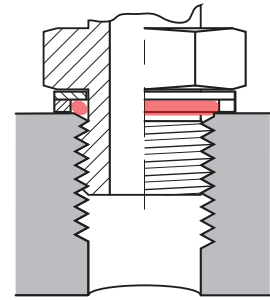

*O-ring is properly installed and fitting torqued*

## Installation of Adjustable Port Fittings

1. Following the above steps (Non-Adjustable & Straight Port Fittings) and stop after step 5.
2. Back off the adjustable nut and backup washer as far back as possible, ensuring the threads are fully exposed.
3. Thread fitting into the port until the seal comes into full contact with the spotface (do not overtighten).
4. If installing an elbow, align the direction of the hose or tube end to a desirable orientation by unscrewing the fitting, but be sure not to go past one full turn.
5. Utilizing 2 wrenches (one being a torque wrench), hold the fitting in position with one wrench while tightening the adjustable nut with the torque wrench. Use suggested torque values.
6. Inspect the assembly to ensure that the O-ring & retaining ring are properly seated, and that there are no leaks.
7. If a crow'sfoot is used with a torque wrench, adjustments might need to be made to the torque settings otherwise overtightening could occur. Consult your manufacturer for instructions.

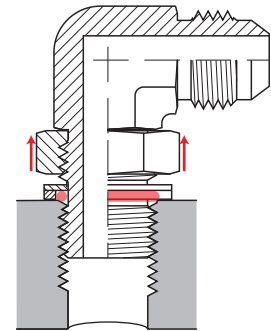

*Adjustable nut and washer are backed all the way off. Fitting is threaded in until seal is touching the port. Fitting is not oriented yet.*

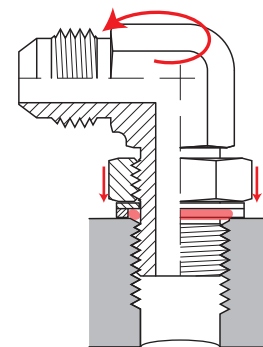

*Orient the fitting to face direction of hose or tube by loosening the fitting, but not more than one turn. Then torque the adjustable nut to suggested setting while holding the fitting body.*



# TECHNICAL HOW TO INSTALL FITTINGS & ADAPTERS

## BSPP Port – Torque Settings

	Dash Size	Inch Thread Size-TPI	Retaining Ring & O-Ring		ED/ES Seal		Bonded Washer	Cutting Face	Banjo	
			Straight (Nm)	Adjustable (Nm)	Straight (Nm)	Plugs (Nm)	Straight (Nm)	Straight (Nm)	With Internal Seals	Without Internal Seals
Light Series (L)	02	1/8-28	18	18	18	13	9	18	18	18
	04	¼-19	35	35	35	30	35	35	45	40
	06	3/8-19	70	70	70	60	45	70	70	65
	08	½-14	90	110	90	80	65	100	120	90
	12	¾-14	180	180	180	140	90	180	230	125
	16	1-11.5	310	310	310	200	150	330	320	
	20	1-1/4-11.5	450	450	450	400	240	540	540	
	24	1-1/2-11.5	540	540	540	450	290	630	700	
Heavy Series (S)	02	1/8-28		25						
	04	¼-19		55	40		35	55	45	
	06	3/8-19		90	80		45	90	70	
	08	½-14		110	115		65	130	120	
	12	¾-14		115	180		90	270	230	
	16	1-11.5		420	310		150	340	320	
	20	1-1/4-11.5		550	450		240	540	540	
	24	1-1/2-11.5		600	540		290	700	700	

# TECHNICAL HOW TO INSTALL FITTINGS & ADAPTERS

## Metric Port – Torque Settings

	Thread Size Mm	Retaining Ring & O-Ring		ED/ES Seal		ISO 6149	Bonded Washer	Cutting Face	Banjo	
		Straight (Nm)	Adjustable (Nm)	Straight (Nm)	Plugs (Nm)	Straight & Adjustable (Nm)	Straight (Nm)	Straight (Nm)	With Internal Seals	Without Internal Seals
Light Series (L)	12	35	35	30	25	25	20	30	45	35
	14	45	45	50	35	35	35	45	55	50
	16	55	55	60	50	40	45	65	80	60
	18	70	70	80	65	45	55	80	100	80
	22	160	180	140	90	60	65	140	140	120
	26	250	180	200	135		90	190	320	130
	27					100				
	33	310	310	380	225	160	150	340	360	
	42	450	450	500	360	210	240	500	540	
	48	540	600	600	360	260	290	630	700	
Heavy Series (S)	12		35	45		35	20	35	45	35
	14		60	60		45	35	55	55	50
	16		95	80		55	45	70	80	60
	18		120	100		70	55	110	100	80
	20			140		80	55	150	125	110
	22		190	150		100	65	170	135	120
	27		190	200		170	90	270	320	135
	33		500	380		310	150	410	360	
	42		600	500		330	240	540	540	
	48		600	600		420	290	700	700	

# TECHNICAL HOW TO INSTALL FITTINGS & ADAPTERS

## Installation of Tapered Port Fittings

When installing tapered fittings, the proper method is to utilize the 'turns from finger tight' method (T.F.F.T). Do not ever use torque settings for tapered fittings as many variables are involved especially when thread tape or sealant is used.

1. Observe unassembled parts, especially threads and bore to ensure it is free of foreign material, burrs, nicks, etc.
2. Apply thread sealant, tape or lubricant if not already applied. Do not cover the first 2 threads with any sealant or lubricant to avoid contaminating the system.
3. If a thread seal tape is used, make sure it is wrapped 1.5 to 2 turns in a clockwise direction when looking at the bore of the fitting.
4. Thread the tapered fitting into port until finger tight.
5. Using the suggested T.F.F.T values in the chart provided, wrench the fitting into place.
6. If the tapered fitting is an elbow, make sure the hose or tube end is oriented in the proper direction without having to loosen the fitting. Serious injury could occur if the fitting is loosened from its suggested T.F.F.T value.
7. Inspect the final assembly for leaks. The number of threads engaged should range from 3.5 and 6.

## BSPT T.F.F.T Values

BSPT Dash Size	Inch Thread Size-TPI	Turns From Finger Tight (T.F.F.T)
02	1/8-18	2 – 3
04	1/4-19	2 – 3
06	3/8-19	2 – 3
08	1/2-14	2 – 3
10	5/8-14	2 – 3
12	3/4-14	2-3
16	1-11.5	1.5 – 2.5
20	1-1/4-11.5	1.5 – 2.5
24	1-1/2-11.5	1.5 – 2.5

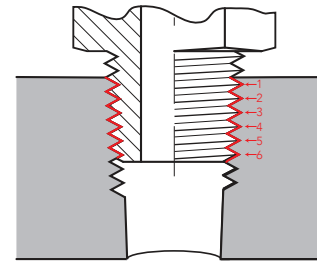

Inspect final assembly to ensure 3.5 to 6 threads are engaged

## Installation of Female Swivel Fittings

1. Observe unassembled parts, especially threads and bore to ensure it is free of foreign material, burrs, nicks, etc.
2. Make sure the seating surface angles are the same for the fittings you are connecting.
3. If there is an O-ring located on one of the cone seats, inspect it for damage and replace if used or worn. Make sure O-ring is seated properly and not cocked or twisted.
4. Never install an O-ring, bonded washer, or other seal at the base of the thread like you would a port fitting. Swivel fittings seal via internal surfaces.
5. Thread and then tighten the swivel nut with a torque wrench while holding the corresponding fitting body with a wrench. Torque to recommended settings.
6. If a crowsfoot is used with a torque wrench, adjustments might need to be made to the torque settings otherwise overtightening could occur. Consult your manufacturer for instructions.
7. Inspect final assembly for leaks.

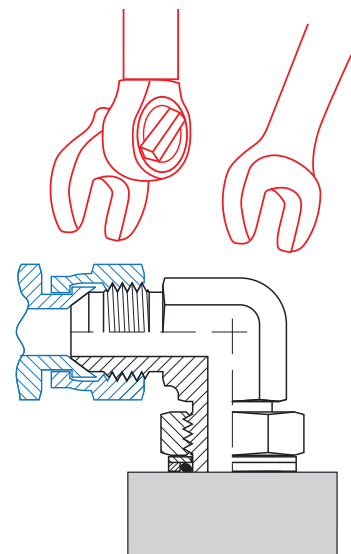

Hand tighten, then orient the fitting to face direction of hose or tube. Then torque the swivel nut to suggested setting while holding the fitting body. Inspect for leaks.

# TECHNICAL HOW TO INSTALL FITTINGS & ADAPTERS

## DIN DKO Swivel - Torque Settings

	Thread Size Mm	Tube Size	DIN DKO Swivel (Nm)
L Light Duty	12	L06	16
	14	L08	16
	16	L10	26
	18	L12	37
	22	L15	47
	26	L18	89
	30	L22	116
	36	L28	137
	45	L35	226
	52	L42	347
S Heavy Duty	14	S06	26
	16	S08	42
	18	S10	53
	20	S12	63
	22	S14	79
	24	S16	84
	30	S20	126
	36	S25	179
	42	S30	263
	52	S38	368

## BSPP Swivel - Torque Settings

Dash Thread Size	Inch Thread Size-Tpi	BSPP Swivel (Nm)
02	1/8-18	
04	1/4-19	20
06	3/8-19	35
08	1/2-14	60
10	5/8-14	70
12	3/4-14	115
16	1-11.5	140
20	1-1/4-11.5	210
24	1-1/2-11.5	290
52	L42	347

### Please note:

- All torque values are intended for steel fittings.
- For Brass fittings and adapters use 65 % of the torque values.
- For Stainless steel fittings and adapters, use 5% higher value than listed and lubricated threads.

## Installation of 24° DIN Tube Fittings

Make sure you fully read and understand the previous sections on DIN tube fittings and verify you have the correct components for your assembly.

1. The first step is to cut the tube to length, then de-burr and clean. Cut tubing with appropriate saw only.
2. Next, pre-set the cutting ring by initiating the bite into the tube. There are two ways to complete the pre-set: either a) manually with a fitting or hardened pre-assembly fitting body, or b) with a hydraulic pre-set machine. Hydraulic pre-setting is recommended for assemblies with tube size greater than 18mm.
3. Perform pre-set inspection to verify proper installation of cutting ring.
4. Install the assembly.

# TECHNICAL HOW TO INSTALL FITTINGS & ADAPTERS

## Manual Pre-set Method for 24° DIN Tube Fittings

1. Lubricate threads of fitting and nut, 24° throat, and cutting ring.
2. Place nut then cutting ring over tube, ensuring proper orientation.
3. Thread nut onto fitting until finger tight. Press tube firmly into the tube receptacle of the fitting while doing so.
4. Mark nut and tube position for reference with soap stone or marking pencil.
5. Tighten nut so that it completes 1.5 turns (use markings as reference), while at the same time ensuring the tube is stationary and pressed firmly into the tube receptacle. Sudden resistance to torquing is a sign the cutting ring is in a desired position. Be sure to secure fitting with wrench while tightening the nut.

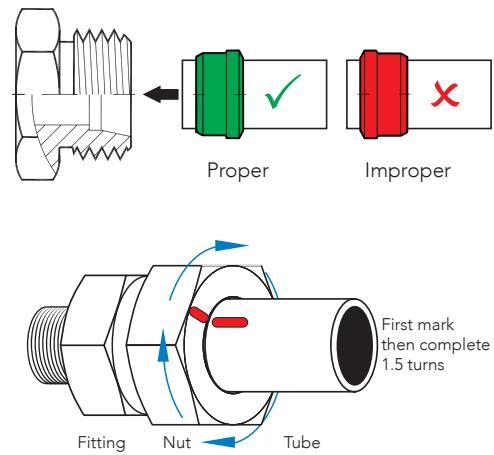

## Hydraulic Pre-set Method for 24° DIN Tube Fittings

There are various hydraulic pre-set machines available with specific instructions for each. Please refer to your user's manual for operating instructions.

### Pre-set Inspection

1. Remove the nut from fitting and pull back in order to inspect the cutting ring.
2. The cutting ring should leave no visible gap between the first cutting surface and the tube, and the tube should have a visible bite edge in front of the cutting ring (looks like slightly raised material).
3. If not, tighten in small increments (checking the result after each increment) to verify cutting ring is properly gripping the tube.

It is possible for the ring to rotate around the tube, however this does not indicate an improper installation as long as all other factors are correct.

### Final Installation

Take the pre-set assembly and insert tube into the fitting's tube receptacle firmly, then tighten nut with light wrenching until resistance felt. Once this has been achieved, tighten the nut another 30° or 1/12th of a turn. This is the equivalent of turning the nut from a state where the hex is flat relative to a fixed point (i.e. a table) to where the sharp edge of the hex is now facing that position. Be sure to use a second wrench to hold the fitting in place while torquing the nut

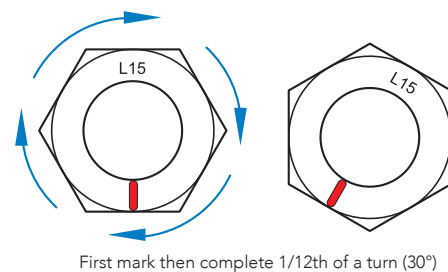
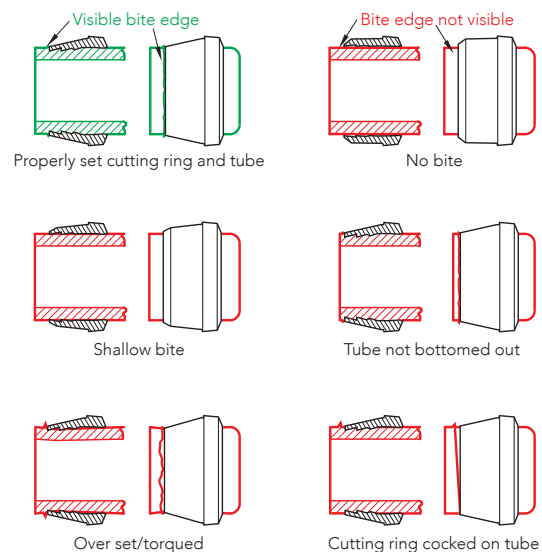

# TECHNICAL HOW TO ORDER DIN FITTINGS FROM ADAPTALL

## How to order 24° DIN Tube Fittings from Adaptall

To order 24° DIN tube fittings from Adaptall it is important to understand the part numbering system. This system is typical of most manufacturers:

1. The first four numbers indicate the part series i.e. 5000 is a male DIN union. The desired series number can be determined by using the 'Visual Reference Guide' on pages 6-7, or the index on page 19.
2. The pressure class (LL, L, or S) is indicated at the end of the series number i.e. 5000L, 5002S, 5063LL, etc.
3. For instances where a DIN x DIN fitting does not have a jump size, only one dash size is displayed. For example, a 5000L-06 is a light duty L06 x L06 DIN union.
4. The dash numbers indicate tube size when describing the DIN side of the fitting. From the last example, a 5000L-06 is an L06 indicating a M12x1.5 thread with 6mm tube receptacle; see 'Component Compatibility Chart' on page 2 for details on tube size & thread size relationship.
5. For non-DIN threads such as NPT, BSPP, etc., the regular dash system is used i.e. -08 indicates 1/2", -12 is 3/4", etc. Adaptall usually displays dash sizes with tube or hose side first, then port side.
6. To order a complete DIN assembly (including fitting, cutting ring, and nut) simply add a "C" to the end of the part number. For example, a complete L06 male DIN union assembly would be 5000L-06C, etc. Please note that all LL series (extra light duty) parts come complete.

When a complete assembly is ordered from Adaptall, there is no need to identify components to go along with your assembly. Adaptall will complete the necessary steps to ensure you are provided with compatible components.

### Example:

Shown here in black only is 5158L-22-22-12: Male DIN X Male BSPP adjustable Run Tee, size L22 for the DIN threads, and dash size 12 BSPP (3/4"). When ordered as part number 5158L-22-22-12C it comes as a complete assembly with cutting rings and nuts for the two L22 Male DIN threads (components shown in green). Looking at the 'Component Compatibility Chart' on page X, one would notice the compatible nuts for this assembly would be 5201L-22 with the compatible cutting rings being 5202-22.

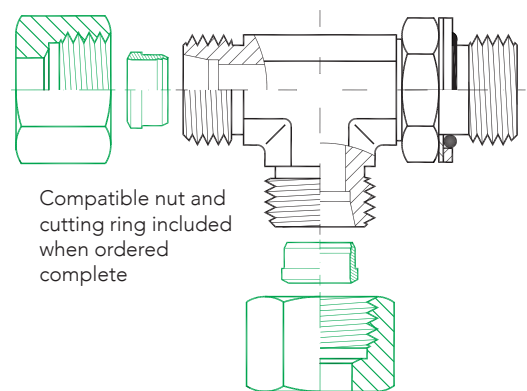

## FEATURED FITTING GAUGES

### TGK-01

BSP & METRIC THREAD ID GAUGE

BSPP, BSPT & JIS GAUGE (x1)

METRIC, DIN, KOBELCO GAUGE (x1)

### TGK-02

JIC, ORB (SAE), NPT AND ORFS THREAD ID GAUGE

JIC & SAE ORB GAUGE (x1)

ORFS GAUGE (x1)

NPT GAUGE (x1)



Use it to verify thread pitch



Ports are used to identify male threads, posts for female threads



Chamfer and nose cone angles can be verified



Affordable and useful in the field



Convenient pouch holds multiple tools

## FEATURED KITS

### KIT-BANJO-BSPP

BSPP BANJO KIT

3002-02 (x4)	3002-12 (x2)	3059-06-06 (x4)	3500-04 (x16)
3002-04 (x8)	3059-04-02 (x4)	3059-08-08 (x2)	3500-06 (x8)
3002-06 (x4)	3059-04-04 (x4)	3059-12-12 (x2)	3500-08 (x4)
3002-08 (x2)	3059-06-04 (x4)	3500-02 (x8)	3500-12 (x4)

### KIT-BANJO-METRIC

METRIC BANJO KIT

3068-08 (x4)	3068-20-150 (x2)	3069-08-18 (x4)	3500-16mm (x8)
3068-10-1 (x4)	3068-22-150 (x2)	3069-08-20 (x2)	3500-18mm (x8)
3068-10-150 (x4)	3069-04-08 (x4)	3069-10-22 (x2)	3500-20mm (x4)
3068-12-150 (x4)	3069-04-10 (x8)	3500-08mm (x8)	3500-22mm (x4)
3068-14-150 (x4)	3069-04-12 (x4)	3500-10mm (x16)	
3068-16-150 (x4)	3069-06-14 (x4)	3500-12mm (x4)	
3068-18-150 (x4)	3069-06-16 (x4)	3500-14mm (x8)	

### KIT-BANJO-BSPP+MET

BSPP AND METRIC BANJO KIT COMBO

BSPP BANJO KIT (x1)
METRIC BANJO KIT (x1)

### KIT-PL&CP-BSPP

BSPP PLUG AND CAP KIT

02 (4 PLUGS, 4 CAPS)	10 (2 PLUGS, 2 CAPS)
04 (4 PLUGS, 4 CAPS)	12 (4 PLUGS, 4 CAPS)
06 (4 PLUGS, 4 CAPS)	16 (2 PLUGS, 2 CAPS)
08 (4 PLUGS, 4 CAPS)	

### KIT-PL&CP-DIN-L

DIN PLUG & CAP KIT - LIGHT

L06 (4 PLUGS, 4 CAPS)	L15 (6 PLUGS, 6 CAPS)
L08 (4 PLUGS, 4 CAPS)	L18 (4 PLUGS, 4 CAPS)
L10 (6 PLUGS, 6 CAPS)	L22 (4 PLUGS, 4 CAPS)
L12 (6 PLUGS, 6 CAPS)	L28 (2 PLUGS, 2 CAPS)

### KIT-PL&CP-DIN-S

DIN PLUG & CAP KIT - HEAVY

S06 (4 PLUGS, 4 CAPS)	S14 (4 PLUGS, 4 CAPS)
S08 (4 PLUGS, 4 CAPS)	S16 (4 PLUGS, 4 CAPS)
S10 (6 PLUGS, 6 CAPS)	S20 (2 PLUGS, 2 CAPS)
S12 (6 PLUGS, 6 CAPS)	S25 (2 PLUGS, 2 CAPS)





## KIT-PL&CP-JIS

JIS PLUG & CAP KIT

04 (2 PLUGS, 2 CAPS)	08 (2 PLUGS, 2 CAPS)	16 (2 PLUGS, 2 CAPS)
06 (2 PLUGS, 2 CAPS)	12 (2 PLUGS, 2 CAPS)	20 (2 PLUGS, 2 CAPS)



## KIT-PL&CP-KOMATSU

KOMATSU PLUG AND CAP KIT

14mm (2 PLUGS, 2 CAPS)	22mm (2 PLUGS, 2 CAPS)	30mm (2 PLUGS, 2 CAPS)
18mm (2 PLUGS, 2 CAPS)	24mm (2 PLUGS, 2 CAPS)	33mm (2 PLUGS, 2 CAPS)



## KIT-9005ES

MJIC X MBSPP ES SEALED DUAL PURPOSE

9005ES-04-02 (x4)	9005ES-06-06 (x4)	9005ES-12-12 (x4)
9005ES-04-04 (x4)	9005ES-08-06 (x4)	9005ES-16-16 (x2)
9005ES-04-06 (x4)	9005ES-08-08 (x4)	
9005ES-06-04 (x4)	9005ES-10-08 (x4)	



## KIT-9197-LIGHT

MJIC X FDIN/DKO KIT - LIGHT

9197-04-L06-12 (x4)	9197-08-L12-18 (x2)	9197-16-L22-30 (x2)
9197-04-L08-14 (x4)	9197-10-L15-22 (x2)	9197-16-L28-36 (x2)
9197-06-L08-14 (x4)	9197-12-L18-26 (x2)	
9197-06-L10-16 (x4)	9197-12-L22-30 (x2)	



## KIT-9197-HEAVY

MJIC X FDIN/DKO KIT - HEAVY

9197-04-S06-14 (x4)	9197-08-S16-24 (x2)
9197-06-S08-16 (x4)	9197-10-S16-24 (x2)
9197-06-S10-18 (x4)	9197-12-S20-30 (x2)
9197-08-S12-20 (x2)	9197-16-S25-36 (x2)



## KIT-SEALS-BSPP+MET

BONDED SEAL KIT BSPP & METRIC

BSPP 02 (x20)	BSPP 16 (x15)	16mm (x20)	27mm (x15)
BSPP 04 (x20)	BSPP 20 (x10)	18mm (x15)	30mm (x20)
BSPP 06 (x20)	8mm (x20)	20mm (x15)	33mm (x10)
BSPP 08 (x20)	10mm (x20)	22mm (x15)	36mm (x10)
BSPP 10 (x15)	12mm (x20)	24mm (x15)	
BSPP 12 (x15)	14mm (x20)	26mm (x20)	



# FEATURED STOCKING PROGRAMS

## IA SSDO

INTERNATIONAL ADAPTERS ROLLING BIN RACK  
240 FULLY STOCKED BINS OF POPULAR SIZES

SELECT SIZES & QTYS OF:

6002 SERIES	9030 SERIES	9605S SERIES
6068 SERIES	9033 SERIES	9606S SERIES
9000 SERIES	9035S SERIES	9635S SERIES
9005ES SERIES	9059 SERIES	9636S SERIES
9006 SERIES	9069 SERIES	TGK GAUGES
9007 SERIES	9197 SERIES	
9011 SERIES	9199 SERIES	
9021 SERIES	9240 SERIES	
9028 SERIES	9500 SERIES	
9029 SERIES	9500MM SERIES	

## DIN SSDO

DIN TUBE FITTINGS & ADAPTERS ROLLING BIN RACK  
240 FULLY STOCKED BINS OF POPULAR SIZES

SELECT SIZES & QTYS IN L & S:

5002 SERIES	5063 SERIES	5201 SERIES	5300 SERIES
5007 SERIES	5068 SERIES	5202 SERIES	5360 SERIES
5011 SERIES	5070 SERIES	5203 SERIES	TGK GAUGES
5055 SERIES	5080 SERIES	5204P SERIES	

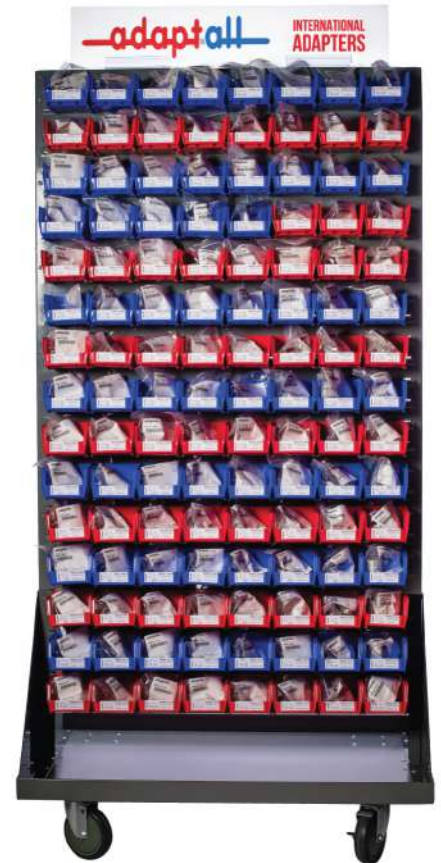

# STEEL BANJO FITTINGS

## 3002

MALE BSPP BANJO BOLT

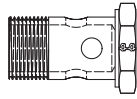

3002-02	3002-06	3002-12
3002-02-21L	3002-08	3002-16
3002-04	3002-08-41L	
3002-04-29L	3002-10	

## 3002DB

BSP DOUBLE BANJO BOLT

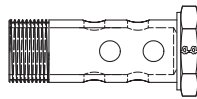

3002DB-02	3002DB-06	3002DB-12
3002DB-04	3002DB-08	3002DB-16

## 3048

MALE UNF BANJO BOLT

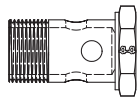

3048-04	3048-10
3048-05	3048-12
3048-06	3048-16
3048-08	

## 3049

MALE JIC X UNF BANJO BODY

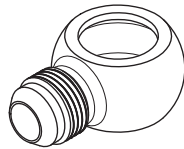

3049-04-04	3049-08-08	3049-16-16
3049-05-04	3049-10-08	
3049-06-04	3049-10-12	
3049-06-06	3049-12-12	

## 3059

MALE JIC X BSP BANJO BODY

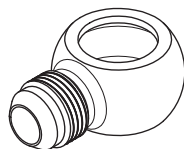

3059-04-02	3059-06-06	3059-12-12
3059-04-04	3059-08-08	3059-12-16
3059-05-04	3059-10-08	
3059-06-04	3059-10-12	

## 3059HB

HOSE BARB X BSP BANJO BODY (LOW PSI)

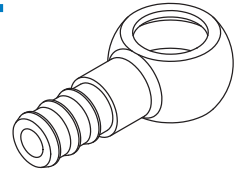

3059HB-04-02	3059HB-05-06	3059HB-08-08
3059HB-04-04	3059HB-06-06	

## 3068

METRIC BANJO BOLT

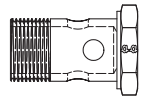

3068-08-1	3068-12-125	3068-18-150-40L
3068-08-125	3068-12-150	3068-20-150
3068-10-1	3068-14-150	3068-22-150
3068-10-125	3068-14-150-27L	3068-24-150
3068-10-150	3068-16-150	3068-26-150
3068-12-1	3068-18-150	

## 3068DB

METRIC DOUBLE BANJO BOLT

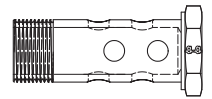

3068DB-8-1	3068DB-14-150
3068DB-10-1	3068DB-16-150
3068DB-12-125	3068DB-18-150
3068DB-12-150	3068DB-22-150

## 3069

MALE JIC X METRIC BANJO BODY

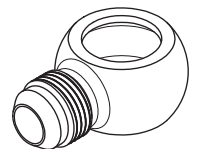

3069-04-08	3069-06-16	3069-10-24
3069-04-10	3069-08-18	3069-12-26
3069-04-12	3069-08-20	
3069-06-14	3069-10-22	

# STEEL BANJO FITTINGS

## 3069HB

HOSE BARB X METRIC BANJO BODY (LOW PSI)

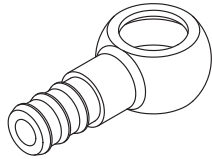

3069HB-04-08	3069HB-06-10	3069HB-08-16
3069HB-04-10	3069HB-06-12	3069HB-12-18
3069HB-05-12	3069HB-06-14	
3069HB-05-14	3069HB-08-14	

## 3069L

MALE DIN LIGHT X METRIC BANJO BODY

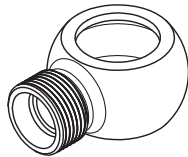

3069L-12-12	3069L-16-16	3069L-22-22
3069L-14-14	3069L-18-18	3069L-26-26

## 3069LL

MALE DIN EXTRA LIGHT X METRIC BANJO BODY

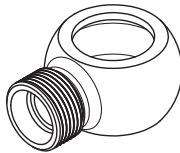

3069LL-10-10
--------------

## 3069S

MALE DIN HEAVY X METRIC BANJO BODY

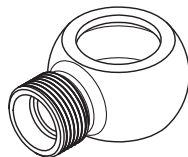

3069S-20-20
3069S-24-24

## 3069WIT

INCH TUBE WELD X METRIC BANJO BODY

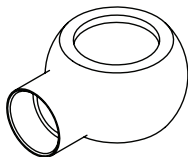

3069WIT-04-02	3069WIT-08-10	3069WIT-12-16
3069WIT-04-04	3069WIT-08-12	3069WIT-16-12
3069WIT-04-06	3069WIT-10-08	3069WIT-16-16
3069WIT-06-04	3069WIT-10-10	
3069WIT-06-06	3069WIT-10-12	
3069WIT-06-08	3069WIT-12-08	
3069WIT-08-06	3069WIT-12-10	
3069WIT-08-08	3069WIT-12-12	

## 3069W

METRIC TUBE WELD X METRIC BANJO BODY

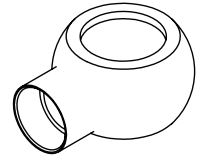

3069W-04-06	3069W-08-18	3069W-14-20
3069W-04-08	3069W-10-12	3069W-14-22
3069W-04-10	3069W-10-14	3069W-15-20
3069W-05-08	3069W-10-16	3069W-16-18
3069W-05-10	3069W-10-18	3069W-16-20
3069W-05-12	3069W-10-20	3069W-16-22
3069W-06-08	3069W-10-22	3069W-16-24
3069W-06-10	3069W-12-14	3069W-18-18
3069W-06-12	3069W-12-16	3069W-18-22
3069W-06-14	3069W-12-18	3069W-18-24
3069W-08-10	3069W-12-20	3069W-20-22
3069W-08-12	3069W-14-16	3069W-20-26
3069W-08-14	3069W-14-18	3069W-22-26
3069W-08-16	3069W-14-20	

## 3500

BSPB COPPER SEALING WASHERS

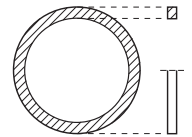

3500-02	3500-10
3500-04	3500-12
3500-06	3500-16
3500-08	

## 3500MM

METRIC COPPER SEALING WASHERS

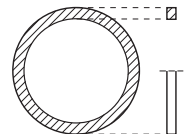

3500-08MM	3500-16MM	3500-24MM
3500-10MM	3500-18MM	3500-26MM
3500-12MM	3500-20MM	
3500-14MM	3500-22MM	

# STEEL DIN TUBE FITTINGS

## 5000L

DIN UNION LIGHT DUTY

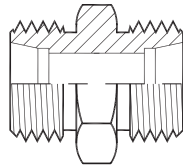

5000L-06	5000L-12-08	5000L-18-15
5000L-08	5000L-12-10	5000L-22
5000L-08-06	5000L-15	5000L-22-15
5000L-10	5000L-15-10	5000L-22-18
5000L-10-06	5000L-15-12	5000L-28
5000L-10-08	5000L-18	5000L-28-22
5000L-12	5000L-18-10	5000L-35
5000L-12-06	5000L-18-12	5000L-42

## 5000LL

DIN UNION EXTRA LIGHT DUTY  
(AVAILABLE COMPLETE ONLY)

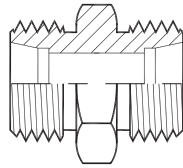

5000LL-04C	5000LL-08C	5000LL-12C
5000LL-06C	5000LL-10C	

## 5000S

DIN UNION HEAVY DUTY

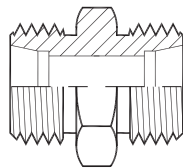

5000S-06	5000S-14	5000S-25-16
5000S-08	5000S-16	5000S-25-20
5000S-10	5000S-16-12	5000S-30
5000S-10-08	5000S-20	5000S-38
5000S-12	5000S-20-16	
5000S-12-10	5000S-25	

## 5002L

DIN LIGHT DUTY X MALE  
BSPP ES

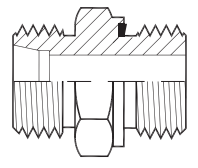

5002L-06-02	5002L-12-06	5002L-28-12
5002L-06-04	5002L-12-08	5002L-28-16
5002L-08-02	5002L-15-06	5002L-35-16
5002L-08-04	5002L-15-08	5002L-35-20
5002L-08-06	5002L-15-12	5002L-42-20
5002L-10-02	5002L-18-08	5002L-42-24
5002L-10-04	5002L-18-12	
5002L-10-06	5002L-22-08	
5002L-10-08	5002L-22-12	
5002L-12-04	5002L-22-16	

## 5002S

DIN HEAVY DUTY X MALE  
BSPP ES SEAL

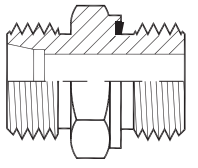

5002S-06-04	5002S-12-08	5002S-20-16
5002S-08-04	5002S-14-06	5002S-25-12
5002S-08-06	5002S-14-08	5002S-25-16
5002S-10-04	5002S-16-06	5002S-30-16
5002S-10-06	5002S-16-08	5002S-30-20
5002S-10-08	5002S-16-12	5002S-38-20
5002S-12-04	5002S-20-08	5002S-38-24
5002S-12-06	5002S-20-12	

## 5006L

DIN LIGHT DUTY X MALE SAE ORB

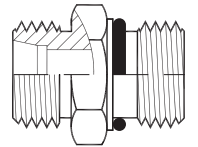

5006L-06-04	5006L-12-08	5006L-22-16
5006L-06-06	5006L-12-10	5006L-28-10
5006L-08-04	5006L-15-08	5006L-28-12
5006L-08-06	5006L-15-10	5006L-28-16
5006L-10-04	5006L-18-08	5006L-35-16
5006L-10-06	5006L-18-10	5006L-35-20
5006L-10-08	5006L-22-10	5006L-42-20
5006L-12-06	5006L-22-12	5006L-42-24

# STEEL DIN TUBE FITTINGS

## 5006S

DIN HEAVY DUTY X MALE SAE ORB

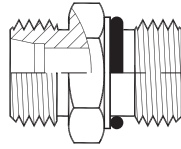

5006S-08-04	5006S-16-10	5006S-30-16
5006S-10-06	5006S-20-08	5006S-30-20
5006S-12-06	5006S-20-10	5006S-38-20
5006S-12-08	5006S-20-12	5006S-38-24
5006S-14-08	5006S-25-12	
5006S-16-08	5006S-25-16	

## 5007L

DIN LIGHT DUTY X MALE NPT

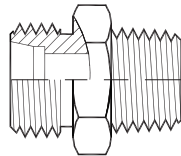

5007L-06-02	5007L-12-04	5007L-28-16
5007L-06-04	5007L-12-06	5007L-35-20
5007L-08-02	5007L-12-08	5007L-42-24
5007L-08-04	5007L-15-06	
5007L-08-06	5007L-15-08	
5007L-10-04	5007L-18-08	
5007L-10-06	5007L-18-12	
5007L-10-08	5007L-22-12	

## 5007LL

DIN EXTRA LIGHT X MALE NPT  
(AVAILABLE COMPLETE ONLY)

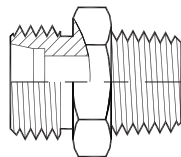

5007LL-04-02C	5007LL-08-02C	5007LL-12-06C
5007LL-06-02C	5007LL-10-04C	5007LL-12-08C

## 5007S

DIN HEAVY DUTY X MALE NPT

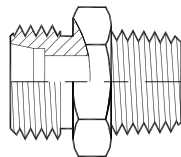

5007S-06-04	5007S-12-08	5007S-20-12
5007S-08-04	5007S-14-06	5007S-25-12
5007S-10-04	5007S-14-08	5007S-25-16
5007S-10-06	5007S-16-06	5007S-30-16
5007S-12-04	5007S-16-08	5007S-30-20
5007S-12-06	5007S-20-08	5007S-38-24

## 5009GCL

LIGHT DUTY GAUGE COUPLING  
FEMALE BSPP

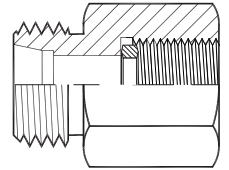

5009GCL-06-04	5009GCL-10-04
5009GCL-08-04	5009GCL-12-04

## 5009GCS

HEAVY DUTY GAUGE COUPLING  
FEMALE BSPP

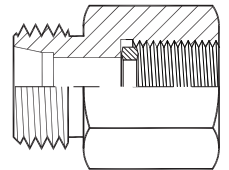

5009GCS-06-08	5009GCS-10-08
5009GCS-08-08	5009GCS-12-08

## 5009L

DIN LIGHT DUTY X FEMALE  
BSP SOLID

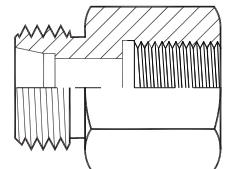

5009L-06-02	5009L-12-06	5009L-22-12
5009L-08-04	5009L-12-08	5009L-28-16
5009L-10-04	5009L-15-08	5009L-35-20
5009L-12-04	5009L-18-08	5009L-42-24

## 5009S

DIN HEAVY DUTY X FEMALE  
BSP SOLID

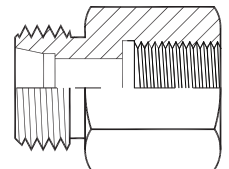

5009S-06-04	5009S-14-08	5009S-30-20
5009S-08-04	5009S-16-08	5009S-38-24
5009S-10-06	5009S-20-12	
5009S-12-06	5009S-25-16	

# STEEL DIN TUBE FITTINGS

## 5011L

DIN LIGHT DUTY X MALE BSPT

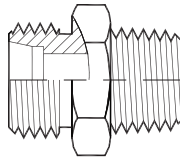

5011L-06-02	5011L-12-04	5011L-28-16
5011L-06-04	5011L-12-06	5011L-35-20
5011L-08-02	5011L-12-08	5011L-42-24
5011L-08-04	5011L-15-06	
5011L-08-06	5011L-15-08	
5011L-10-02	5011L-18-08	
5011L-10-04	5011L-18-12	
5011L-10-06	5011L-22-12	

## 5011LL

DIN EXTRA LIGHT DUTY X MALE BSPT (AVAILABLE COMPLETE ONLY)

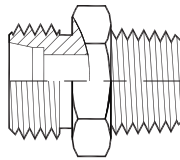

5011LL-04-02C	5011LL-08-02C	5011LL-10-04C
5011LL-06-02C	5011LL-08-04C	5011LL-12-06C

## 5011S

DIN HEAVY DUTY X MALE BSPT

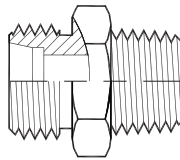

5011S-06-04	5011S-14-08	5011S-25-16
5011S-08-04	5011S-16-06	5011S-30-16
5011S-10-06	5011S-16-08	5011S-30-20
5011S-12-06	5011S-20-08	5011S-38-24
5011S-12-08	5011S-20-12	
5011S-14-06	5011S-25-12	

## 5040ES-L

DIN LIGHT BULKHEAD X MALE BSPP ES SEAL

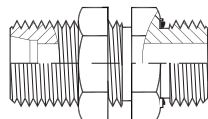

5040-L06-02ESX	5040-L12-08ESX	5040-L18-12ESX
5040-L10-06ESX	5040-L15-12ESX	

## 5040ES-S

DIN HEAVY BULKHEAD X MALE BSPP ES SEAL

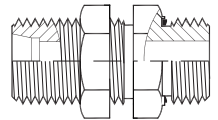

5040-S10-04ESX	5040-S16-08ESX
5040-S12-06ESX	5040-S16-12ESX
5040-S12-08ESX	5040-S20-08ESX
5040-S14-08ESX	5040-S25-16ESX

## 5040L

DIN BULKHEAD UNION LIGHT DUTY

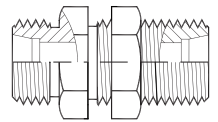

5040L-06	5040L-15	5040L-35
5040L-08	5040L-18	5040L-42
5040L-10	5040L-22	
5040L-12	5040L-28	

## 5040S

DIN BULKHEAD UNION HEAVY DUTY

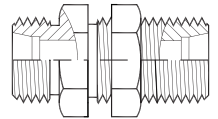

5040S-06	5040S-14	5040S-30
5040S-08	5040S-16	5040S-38
5040S-10	5040S-20	
5040S-12	5040S-25	

## 5041

METRIC THREAD BULKHEAD NUT

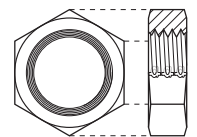

5041-12	5041-24	5041-52
5041-14	5041-26	
5041-16	5041-30	
5041-18	5041-36	
5041-20	5041-42	
5041-22	5041-45	

# STEEL DIN TUBE FITTINGS

## 5042L

90° DIN LIGHT DUTY BULKHEAD UNION

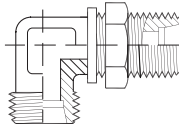

5042L-06	5042L-15	5042L-35
5042L-08	5042L-18	5042L-42
5042L-10	5042L-22	
5042L-12	5042L-28	

## 5042S

90° DIN HEAVY DUTY BULKHEAD UNION

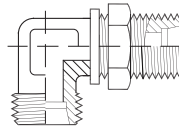

5042S-06	5042S-14	5042S-30
5042S-08	5042S-16	5042S-38
5042S-10	5042S-20	
5042S-12	5042S-25	

## 5055L

90° DIN UNION LIGHT DUTY

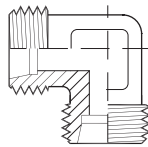

5055L-06	5055L-15	5055L-35
5055L-08	5055L-18	5055L-42
5055L-10	5055L-22	
5055L-12	5055L-28	

## 5055LL

90° DIN UNION EXTRA LIGHT DUTY  
(AVAILABLE COMPLETE ONLY)

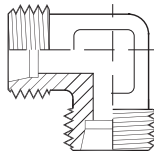

5055LL-04C	5055LL-08C	5055LL-12C
5055LL-06C	5055LL-10C	

## 5055S

90° DIN UNION HEAVY DUTY

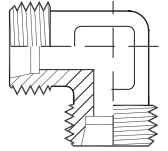

5055S-06	5055S-14	5055S-30
5055S-08	5055S-16	5055S-38
5055S-10	5055S-20	
5055S-12	5055S-25	

## 5058L

45° DIN LIGHT DUTY X MALE BSPP ADJUSTABLE

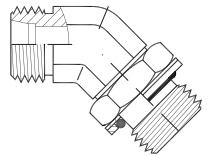

5058L-06-02	5058L-15-08
5058L-08-04	5058L-18-08
5058L-10-04	5058L-22-12
5058L-12-06	5058L-28-16

## 5058S

45° DIN HEAVY DUTY X MALE BSPP ADJUSTABLE

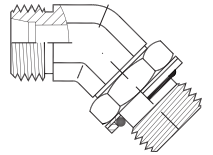

5058S-06-04	5058S-14-08
5058S-08-04	5058S-16-08
5058S-10-06	5058S-20-12
5058S-12-06	5058S-25-16

## 5059BJL

DIN LIGHT DUTY BANJO X MALE BSPP ES SEAL

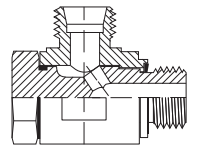

5059BJL-06-02	5059BJL-15-08	5059BJL-35-20
5059BJL-08-04	5059BJL-18-08	5059BJL-42-24
5059BJL-10-04	5059BJL-22-12	
5059BJL-12-06	5059BJL-28-16	



# STEEL DIN TUBE FITTINGS

## 5059BJS

DIN HEAVY DUTY BANJO X MALE  
BSPP ES SEAL

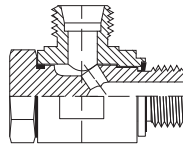

5059BJS-06-04	5059BJS-14-08	5059BJS-30-20
5059BJS-08-04	5059BJS-16-08	5059BJS-38-24
5059BJS-10-06	5059BJS-20-12	
5059BJS-12-06	5059BJS-25-16	

## 5059L

90° DIN LIGHT DUTY X MALE BSPP  
ADJUSTABLE ELBOW

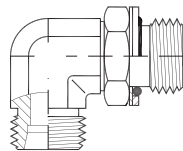

5059L-06-02	5059L-15-06	5059L-35-20
5059L-08-04	5059L-15-08	5059L-42-24
5059L-10-04	5059L-18-08	
5059L-10-06	5059L-18-12	
5059L-12-06	5059L-22-12	
5059L-12-08	5059L-28-16	

## 5059S

90° DIN HEAVY DUTY X MALE  
BSPP ADJUSTABLE ELBOW

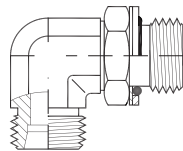

5059S-06-04	5059S-14-08	5059S-30-20
5059S-08-04	5059S-16-08	5059S-38-24
5059S-10-06	5059S-20-12	
5059S-12-06	5059S-25-16	

## 5063L

90° DIN LIGHT DUTY X MALE BSPT  
ELBOW

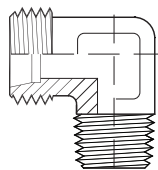

5063L-06-02	5063L-12-04	5063L-28-16
5063L-06-04	5063L-12-06	5063L-35-20
5063L-08-02	5063L-12-08	5063L-42-24
5063L-08-04	5063L-15-06	
5063L-10-02	5063L-15-08	
5063L-10-04	5063L-18-08	
5063L-10-06	5063L-18-12	
5063L-10-08	5063L-22-12	

## 5063LL

90° DIN EXTRA LIGHT DUTY X  
MALE BSPT (AVAILABLE COMPLETE  
ONLY)

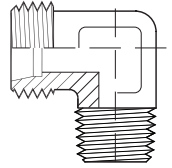

5063LL-04-02C	5063LL-08-02C	5063LL-12-06C
5063LL-06-02C	5063LL-10-04C	

## 5063S

90° DIN HEAVY DUTY X MALE  
BSPT ELBOW

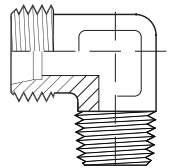

5063S-06-04	5063S-14-08	5063S-25-16
5063S-08-04	5063S-16-06	5063S-30-16
5063S-10-06	5063S-16-08	5063S-30-20
5063S-12-06	5063S-20-08	5063S-38-24
5063S-12-08	5063S-20-12	
5063S-14-06	5063S-25-12	

## 5066L

45° DIN LIGHT DUTY X MALE  
METRIC ADJUSTABLE

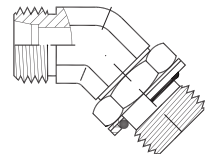

5066L-06-10	5066L-15-18
5066L-08-12	5066L-18-22
5066L-10-14	5066L-22-27
5066L-12-16	5066L-28-33

## 5066S

45° DIN HEAVY DUTY X MALE  
METRIC ADJUSTABLE

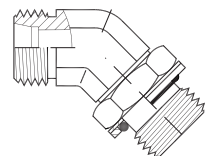

5066S-06-12	5066S-14-20
5066S-08-14	5066S-16-22
5066S-10-16	5066S-20-27
5066S-12-18	5066S-25-33

# STEEL DIN TUBE FITTINGS

## 5068L

DIN LIGHT DUTY X MALE METRIC  
ES SEAL

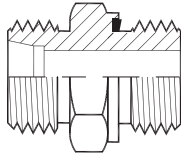

5068L-06-10	5068L-12-14	5068L-18-22
5068L-08-10	5068L-12-16	5068L-22-22
5068L-08-12	5068L-12-18	5068L-22-26
5068L-08-18	5068L-12-22	5068L-28-33
5068L-10-14	5068L-15-16	5068L-35-42
5068L-10-16	5068L-15-18	5068L-42-48
5068L-10-18	5068L-15-22	
5068L-10-22	5068L-18-18	

## 5068S

DIN HEAVY DUTY X MALE METRIC  
ES SEAL

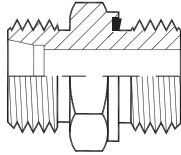

5068S-06-12	5068S-16-18	5068S-30-33
5068S-08-14	5068S-16-22	5068S-30-42
5068S-10-16	5068S-20-22	5068S-38-48
5068S-12-18	5068S-20-27	
5068S-12-22	5068S-25-27	
5068S-14-20	5068S-25-33	

## 5068LLT

DIN EXTRA LIGHT DUTY X MALE  
METRIC TAPER (AVAILABLE COMPLETE  
ONLY)

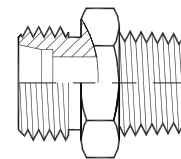

5068LLT-04-6X1C	5068LLT-06-10X1C
5068LLT-04-8X1C	5068LLT-08-10X1C

## 5069BJL

DIN LIGHT BANJO X MALE METRIC  
ES SEAL

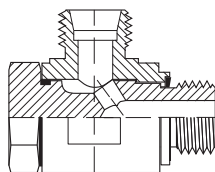

5069BJL-06-10	5069BJL-15-18	5069BJL-35-42
5069BJL-08-12	5069BJL-18-22	5069BJL-42-48
5069BJL-10-14	5069BJL-22-26	
5069BJL-12-16	5069BJL-28-33	

## 5069BJS

DIN HEAVY BANJO X MALE  
METRIC ES SEAL

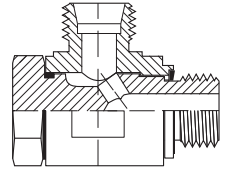

5069BJS-06-12	5069BJS-14-20	5069BJS-30-42
5069BJS-08-14	5069BJS-16-22	5069BJS-38-48
5069BJS-10-16	5069BJS-20-27	
5069BJS-12-18	5069BJS-25-33	

## 5069L

90° DIN LIGHT DUTY X MALE  
METRIC ADJUSTABLE

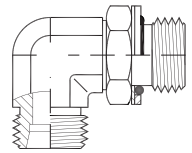

5069L-06-10	5069L-15-18	5069L-35-42
5069L-08-12	5069L-18-22	5069L-42-48
5069L-10-14	5069L-22-27	
5069L-12-16	5069L-28-33	

## 5069S

90° DIN HEAVY DUTY X MALE  
METRIC ADJUSTABLE

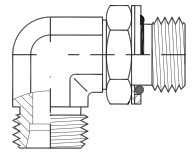

5069S-06-12	5069S-14-20	5069S-30-42
5069S-08-14	5069S-16-22	5069S-38-48
5069S-10-16	5069S-20-27	
5069S-12-18	5069S-25-33	

## 5069LLT

90° DIN EXTRA LIGHT DUTY X  
MALE METRIC TAPER (AVAILABLE  
COMPLETE ONLY)

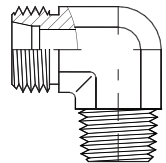

5069LLT-06-10X1C
5069LLT-08-10X1C

# STEEL DIN TUBE FITTINGS

## 5070L

90° DIN LIGHT DUTY X MALE NPT

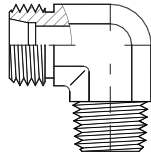

5070L-06-02	5070L-12-04	5070L-28-16
5070L-06-04	5070L-12-06	5070L-35-20
5070L-08-02	5070L-12-08	5070L-42-24
5070L-08-04	5070L-15-06	
5070L-10-02	5070L-15-08	
5070L-10-04	5070L-18-08	
5070L-10-06	5070L-18-12	
5070L-10-08	5070L-22-12	

## 5070LL

90° DIN EXTRA LIGHT DUTY X MALE NPT (AVAILABLE COMPLETE ONLY)

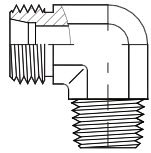

5070LL-04-02C	5070LL-08-02C	5070LL-12-06C
5070LL-06-02C	5070LL-10-04C	

## 5070S

90° DIN HEAVY DUTY X MALE NPT

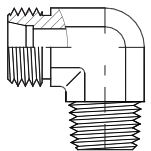

5070S-06-04	5070S-14-08	5070S-25-16
5070S-08-04	5070S-16-06	5070S-30-16
5070S-10-06	5070S-16-08	5070S-30-20
5070S-12-06	5070S-20-08	5070S-38-24
5070S-12-08	5070S-20-12	
5070S-14-06	5070S-25-12	

## 5077L

90° DIN LIGHT DUTY X MALE SAE ORB ADJUSTABLE

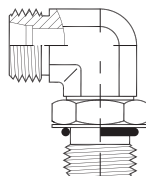

5077L-06-04	5077L-15-10	5077L-35-20
5077L-08-04	5077L-18-10	5077L-42-24
5077L-10-06	5077L-22-12	
5077L-12-08	5077L-28-16	

## 5077S

90° DIN HEAVY DUTY X MALE SAE ORB ADJUSTABLE

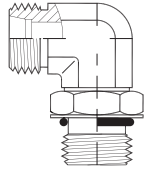

5077S-06-04	5077S-14-10	5077S-30-20
5077S-08-06	5077S-16-10	5077S-38-24
5077S-10-06	5077S-20-12	
5077S-12-08	5077S-25-16	

## 5080L

DIN UNION TEE LIGHT DUTY

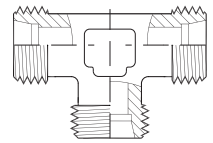

5080L-06	5080L-15	5080L-18-18-15
5080L-08	5080L-15-12-12	5080L-22
5080L-10	5080L-15-12-15	5080L-22-22-10
5080L-10-10-06	5080L-15-15-08	5080L-22-22-15
5080L-10-10-08	5080L-15-15-10	5080L-28
5080L-12	5080L-15-15-12	5080L-28-22-22
5080L-12-12-06	5080L-18	5080L-28-28-22
5080L-12-12-08	5080L-18-12-12	5080L-35
5080L-12-12-10	5080L-18-18-10	5080L-42
5080L-12-12-15	5080L-18-18-12	

## 5080LL

DIN UNION TEE EXTRA LIGHT DUTY (AVAILABLE COMPLETE ONLY)

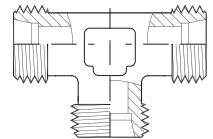

5080LL-04C	5080LL-08C	5080LL-12C
5080LL-06C	5080LL-10C	

## 5080S

DIN UNION TEE HEAVY DUTY

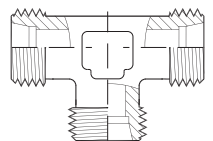

5080S-06	5080S-14	5080S-30
5080S-08	5080S-16	5080S-38
5080S-10	5080S-20	
5080S-12	5080S-25	

# STEEL DIN TUBE FITTINGS

## 5096L

DIN UNION CROSS LIGHT DUTY

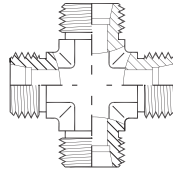

5096L-06  
5096L-08

5096L-10  
5096L-12

## 5096S

DIN UNION CROSS HEAVY DUTY

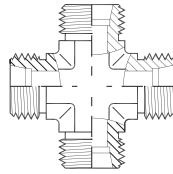

5096S-06  
5096S-08

5096S-10  
5096S-12

## 5158L

DIN LIGHT DUTY X MALE BSPP  
ADJUSTABLE RUN TEE

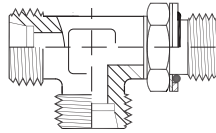

5158L-06-06-02  
5158L-08-08-04  
5158L-10-10-04  
5158L-12-12-06

5158L-15-15-08  
5158L-18-18-08  
5158L-22-22-12  
5158L-28-28-16

5158L-35-35-20  
5158L-42-42-24

## 5158S

DIN HEAVY DUTY X MALE BSPP  
ADJUSTABLE RUN TEE

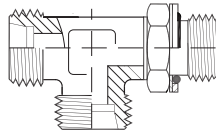

5158S-06-06-04  
5158S-08-08-04  
5158S-10-10-06  
5158S-12-12-06

5158S-14-14-08  
5158S-16-16-08  
5158S-20-20-12  
5158S-25-25-16

5158S-30-30-20  
5158S-38-38-24

## 5159L

DIN LIGHT DUTY X MALE BSPP  
ADJUSTABLE BRANCH TEE

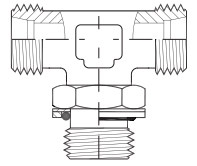

5159L-06-06-02  
5159L-08-08-04  
5159L-10-10-04  
5159L-12-12-06

5159L-15-15-08  
5159L-18-18-08  
5159L-22-22-12  
5159L-28-28-16

5159L-35-35-20  
5159L-42-42-24

## 5159S

DIN HEAVY DUTY X MALE BSPP  
ADJUSTABLE BRANCH TEE

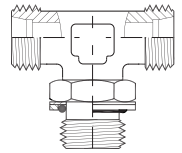

5159S-06-06-04  
5159S-08-08-04  
5159S-10-10-06  
5159S-12-12-06

5159S-14-14-08  
5159S-16-16-08  
5159S-20-20-12  
5159S-25-25-16

5159S-30-30-20  
5159S-38-38-24

## 5168L

DIN LIGHT DUTY X MALE METRIC  
ADJUSTABLE RUN TEE

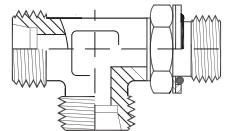

5168L-06-06-10  
5168L-08-08-12  
5168L-10-10-14  
5168L-12-12-16

5168L-15-15-18  
5168L-18-18-22  
5168L-22-22-27  
5168L-28-28-33

5168L-35-35-42  
5168L-42-42-48

## 5168S

DIN HEAVY DUTY X MALE METRIC  
ADJUSTABLE RUN TEE

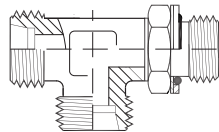

5168S-06-06-12  
5168S-08-08-14  
5168S-10-10-16  
5168S-12-12-18

5168S-14-14-20  
5168S-16-16-22  
5168S-20-20-27  
5168S-25-25-33

5168S-30-30-42  
5168S-38-38-48

# STEEL DIN TUBE FITTINGS

## 5169L

DIN LIGHT DUTY X MALE METRIC  
ADJUSTABLE BRANCH TEE

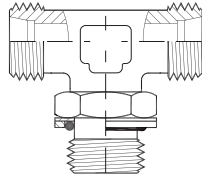

5169L-06-06-10	5169L-15-15-18	5169L-35-35-42
5169L-08-08-12	5169L-18-18-22	5169L-42-42-48
5169L-10-10-14	5169L-22-22-27	
5169L-12-12-16	5169L-28-28-33	

## 5179L

DIN LIGHT DUTY X MALE SAE ORB  
ADJUSTABLE BRANCH TEE

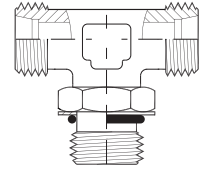

5179L-06-06-04	5179L-15-15-10	5179L-28-28-16
5179L-08-08-04	5179L-18-18-10	5179L-35-35-20
5179L-10-10-06	5179L-18-18-12	5179L-42-42-24
5179L-12-12-08	5179L-22-22-12	

## 5169S

DIN HEAVY DUTY X MALE METRIC  
ADJUSTABLE BRANCH TEE

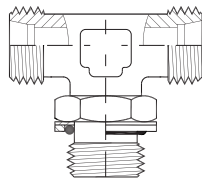

5169S-06-06-12	5169S-14-14-20	5169S-30-30-42
5169S-08-08-14	5169S-16-16-22	5169S-38-38-48
5169S-10-10-16	5169S-20-20-27	
5169S-12-12-18	5169S-25-25-33	

## 5179S

DIN HEAVY DUTY X MALE SAE ORB  
ADJUSTABLE BRANCH TEE

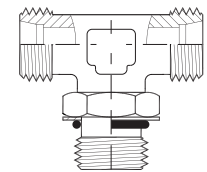

5179S-06-06-04	5179S-14-14-10	5179S-30-30-20
5179S-08-08-06	5179S-16-16-10	5179S-38-38-24
5179S-10-10-06	5179S-20-20-12	
5179S-12-12-08	5179S-25-25-16	

## 5178L

DIN LIGHT DUTY X MALE SAE ORB  
ADJUSTABLE RUN TEE

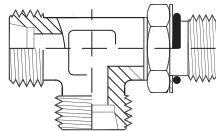

5178L-06-06-04	5178L-15-15-10	5178L-35-35-20
5178L-08-08-04	5178L-18-18-10	5178L-42-42-24
5178L-10-10-06	5178L-22-22-12	
5178L-12-12-08	5178L-28-28-16	

## 5201L

DIN LIGHT DUTY TUBE NUT

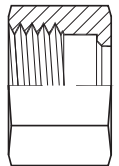

5201L-06	5201L-22	5201L-42
5201L-08	5201L-22-30X1.5	
5201L-10	5201L-28	
5201L-12	5201L-28-36X1.5	
5201L-15	5201L-35	
5201L-18	5201L-35-45X1.5	

## 5178S

DIN HEAVY DUTY X MALE SAE ORB  
ADJUSTABLE RUN TEE

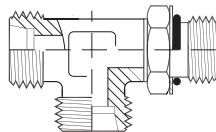

5178S-06-06-04	5178S-14-14-10	5178S-30-30-20
5178S-08-08-06	5178S-16-16-10	5178S-38-38-24
5178S-10-10-06	5178S-20-20-12	
5178S-12-12-08	5178S-25-25-16	

## 5201LL

DIN EXTRA LIGHT DUTY TUBE NUT

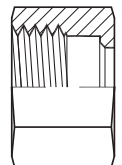

5201LL-04	5201LL-08	5201LL-12
5201LL-06	5201LL-10	

# STEEL DIN TUBE FITTINGS

## 5201S

DIN HEAVY DUTY TUBE NUT

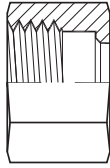

5201S-06	5201S-14	5201S-30
5201S-08	5201S-16	5201S-38
5201S-10	5201S-20	
5201S-12	5201S-25	

## 5203S

DIN HEAVY DUTY TUBE PLUG

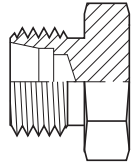

5203S-06	5203S-14	5203S-30
5203S-08	5203S-16	5203S-38
5203S-10	5203S-20	5203L-42
5203S-12	5203S-25	

## 5202

DIN 2353 CUTTING RING



5202-06	5202-16	5202-30
5202-08	5202-18	5202-35
5202-10	5202-20	5202-38
5202-12	5202-22	5202-42
5202-14	5202-25	
5202-15	5202-28	

## 5204L

DIN LIGHT DUTY TUBE CAP

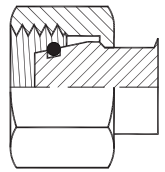

5204L-06	5204L-15	5204L-35
5204L-08	5204L-18	5204L-42
5204L-10	5204L-22	
5204L-12	5204L-28	

## 5202LL

DIN 2353 EXTRA LIGHT CUTTING RING



5202LL-04	5202LL-08	5202LL-12
5202LL-06	5202LL-10	

## 5204S

DIN HEAVY DUTY TUBE CAP

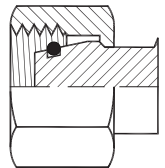

5204S-06	5204S-14	5204S-30
5204S-08	5204S-16	5204S-38
5204S-10	5204S-20	
5204S-12	5204S-25	

## 5203L

DIN LIGHT DUTY TUBE PLUG

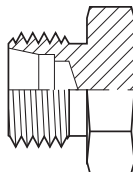

5203L-06	5203L-15	5203L-28
5203L-08	5203L-18	5203L-35
5203L-10	5203L-22	5203L-42
5203L-12	5203L-22-30X1.5	

## 5204P

DIN BLANKING PLUG

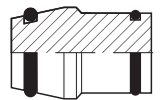

5204P-06	5204P-16	5204P-30
5204P-08	5204P-18	5204P-35
5204P-10	5204P-20	5204P-38
5204P-12	5204P-22	5204P-42
5204P-14	5204P-25	
5204P-15	5204P-28	

# STEEL DIN TUBE FITTINGS

## 5300L

FEMALE DIN LIGHT SOFT SEAL UNION

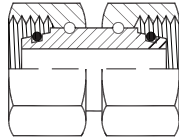

5300L-06  
5300L-08  
5300L-10  
5300L-12

5300L-15  
5300L-18  
5300L-22  
5300L-28

5300L-35  
5300L-42

## 5300S

FEMALE DIN HEAVY SOFT SEAL UNION

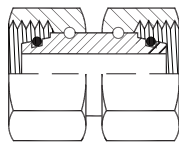

5300S-06  
5300S-08  
5300S-10  
5300S-12

5300S-14  
5300S-16  
5300S-20  
5300S-25

5300S-30  
5300S-38

## 5302L

FEMALE DIN LIGHT DUTY X MALE BSP ES SEAL

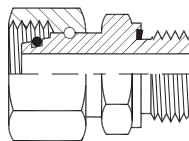

5302L-06-02  
5302L-08-04  
5302L-10-04  
5302L-12-04

5302L-12-06  
5302L-15-08  
5302L-18-08  
5302L-18-12

5302L-22-12  
5302L-28-16  
5302L-35-20  
5302L-42-24

## 5302S

FEMALE DIN HEAVY DUTY X MALE BSP ES SEAL

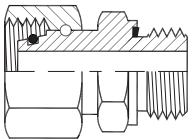

5302S-06-04  
5302S-08-04  
5302S-10-06  
5302S-12-06

5302S-12-08  
5302S-14-08  
5302S-16-08  
5302S-20-12

5302S-25-16  
5302S-30-20  
5302S-38-24

## 5307L

FEMALE DIN LIGHT DUTY X MALE NPT

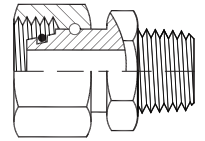

5307L-06-02  
5307L-08-04  
5307L-10-04  
5307L-12-06

5307L-15-08  
5307L-18-08  
5307L-22-12  
5307L-28-16

5307L-35-20  
5307L-42-24

## 5307S

FEMALE DIN HEAVY DUTY X MALE NPT

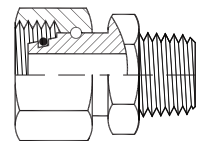

5307S-06-04  
5307S-08-04  
5307S-10-06  
5307S-12-06

5307S-14-08  
5307S-16-08  
5307S-20-12  
5307S-25-16

5307S-30-20  
5307S-38-24

## 5309GCL

FEMALE DIN LIGHT DUTY X FEMALE BSP GAUGE COUPLING

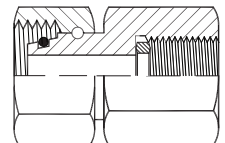

5309GCL-06-04  
5309GCL-08-04

5309GCL-10-04  
5309GCL-12-04

## 5309GCS

FEMALE DIN HEAVY DUTY X FEMALE BSP GAUGE COUPLING

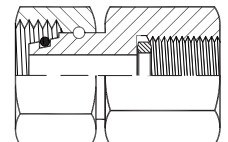

5309GCS-06-08  
5309GCS-08-08

5309GCS-10-08  
5309GCS-12-08

# STEEL DIN TUBE FITTINGS

## 5315L

FEMALE DIN X MALE DIN REDUCER  
LIGHT DUTY

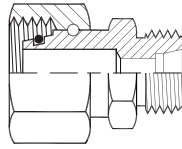

5315L-08-06	5315L-22-08	5315L-35-15
5315L-10-06	5315L-22-10	5315L-35-18
5315L-10-08	5315L-22-12	5315L-35-22
5315L-12-06	5315L-22-15	5315L-35-28
5315L-12-08	5315L-22-18	5315L-42-06
5315L-12-10	5315L-28-06	5315L-42-08
5315L-15-06	5315L-28-08	5315L-42-10
5315L-15-08	5315L-28-10	5315L-42-12
5315L-15-10	5315L-28-12	5315L-42-15
5315L-15-12	5315L-28-15	5315L-42-18
5315L-18-06	5315L-28-18	5315L-42-22
5315L-18-08	5315L-28-22	5315L-42-28
5315L-18-10	5315L-35-06	5315L-42-35
5315L-18-12	5315L-35-08	
5315L-18-15	5315L-35-10	
5315L-22-06	5315L-35-12	

## 5360L

90° DIN LIGHT DUTY X FEMALE  
DIN SWIVEL

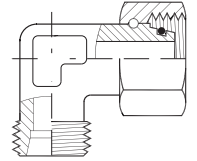

5360L-06	5360L-15	5360L-35
5360L-08	5360L-18	5360L-42
5360L-10	5360L-22	
5360L-12	5360L-28	

## 5360S

90° DIN HEAVY DUTY X FEMALE  
DIN SWIVEL

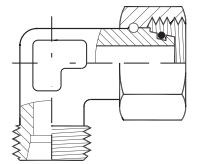

5360S-06	5360S-14	5360S-30
5360S-08	5360S-16	5360S-38
5360S-10	5360S-20	
5360S-12	5360S-25	

## 5315S

FEMALE DIN X MALE DIN REDUCER  
HEAVY DUTY

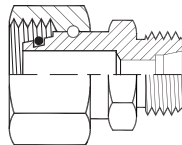

5315S-08-06	5315S-20-08	5315S-30-14
5315S-10-06	5315S-20-10	5315S-30-16
5315S-10-08	5315S-20-12	5315S-30-20
5315S-12-06	5315S-20-14	5315S-30-25
5315S-12-08	5315S-20-16	5315S-38-06
5315S-12-10	5315S-25-06	5315S-38-08
5315S-14-06	5315S-25-08	5315S-38-10
5315S-14-08	5315S-25-10	5315S-38-12
5315S-14-10	5315S-25-12	5315S-38-14
5315S-14-12	5315S-25-14	5315S-38-16
5315S-16-06	5315S-25-16	5315S-38-20
5315S-16-08	5315S-25-20	5315S-38-25
5315S-16-10	5315S-30-06	5315S-38-30
5315S-16-12	5315S-30-08	
5315S-16-14	5315S-30-10	
5315S-20-06	5315S-30-12	

## 5362L

45° DIN X FEMALE DIN SWIVEL  
LIGHT DUTY

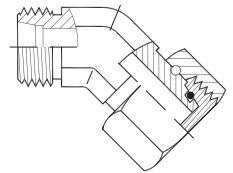

5362L-06	5362L-15	5362L-35
5362L-08	5362L-18	5362L-42
5362L-10	5362L-22	
5362L-12	5362L-28	

## 5362S

45° DIN X FEMALE DIN SWIVEL  
HEAVY DUTY

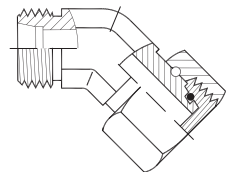

5362S-06	5362S-14	5362S-30
5362S-08	5362S-16	5362S-38
5362S-10	5362S-20	
5362S-12	5362S-25	



# STEEL DIN TUBE FITTINGS

## 5368L

FEMALE DIN LIGHT DUTY X MALE  
METRIC ES SEAL

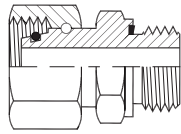

5368L-06-10	5368L-15-18	5368L-35-42
5368L-08-12	5368L-18-22	5368L-42-48
5368L-10-14	5368L-22-26	
5368L-12-16	5368L-28-33	

## 5368S

FEMALE DIN HEAVY DUTY X MALE  
METRIC ES SEAL

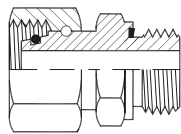

5368S-06-12	5368S-14-20	5368S-30-42
5368S-08-14	5368S-16-22	5368S-38-48
5368S-10-16	5368S-20-27	
5368S-12-18	5368S-25-33	

## 5387L

DIN X FEMALE DIN LIGHT DUTY  
SWIVEL BRANCH TEE

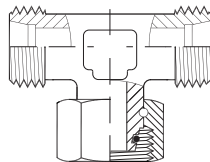

5368S-06-12	5368S-14-20	5368S-30-42
5368S-08-14	5368S-16-22	5368S-38-48
5368S-10-16	5368S-20-27	
5368S-12-18	5368S-25-33	

## 5387S

DIN X FEMALE DIN HEAVY DUTY  
SWIVEL BRANCH TEE

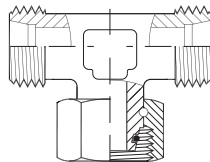

5387S-06	5387S-14	5387S-30
5387S-08	5387S-16	5387S-38
5387S-10	5387S-20	
5387S-12	5387S-25	

## 5390L

DIN X FEMALE DIN LIGHT DUTY  
SWIVEL RUN TEE

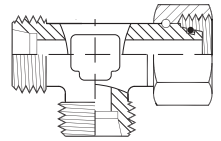

5390L-06	5390L-15	5390L-35
5390L-08	5390L-18	5390L-42
5390L-10	5390L-22	
5390L-12	5390L-28	

## 5390S

DIN X FEMALE DIN HEAVY DUTY  
SWIVEL RUN TEE

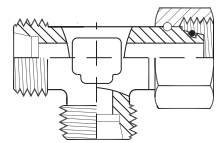

5390S-06	5390S-14	5390S-30
5390S-08	5390S-16	5390S-38
5390S-10	5390S-20	
5390S-12	5390S-25	

# STEEL INTERNATIONAL ADAPTERS

## 3705

90° MALE JIC X FEMALE JIC  
ELBOW

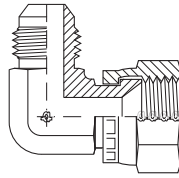

3705-04-04	3705-10-10	3705-24-24
3705-05-05	3705-12-12	
3705-06-06	3705-16-16	
3705-08-08	3705-20-20	

## 4757

MALE JIC X FEMALE JIC RUN TEE

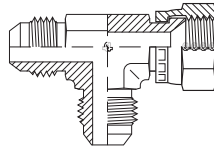

4757-04-04-04	4757-10-10-10	4757-24-24-24
4757-05-05-05	4757-12-12-12	
4757-06-06-06	4757-16-16-16	
4757-08-08-08	4757-20-20-20	

## 4775

MALE JIC X FEMALE JIC BRANCH  
TEE

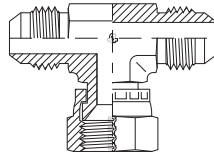

4775-04-04-04	4775-10-10-10	4775-24-24-24
4775-05-05-05	4775-12-12-12	
4775-06-06-06	4775-16-16-16	
4775-08-08-08	4775-20-20-20	

## 6002

MALE ORFS X MALE BSPP C/W  
SEAL

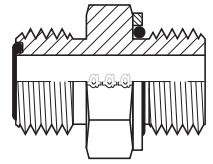

6002-04-02	6002-08-08	6002-16-16
6002-04-04	6002-08-12	6002-16-20
6002-04-06	6002-08-16	6002-20-16
6002-06-04	6002-10-08	6002-20-20
6002-06-06	6002-12-08	6002-20-24
6002-06-08	6002-12-12	6002-24-20
6002-08-04	6002-12-16	6002-24-24
6002-08-06	6002-16-12	

## 6002L

MALE ORFS X MALE BSPP LONG  
C/W OR & RR

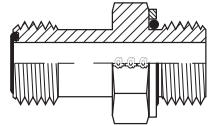

6002L-08-06	6002L-12-12
6002L-08-08	6002L-16-16
6002L-10-08	6002L-20-20
6002L-10-12	

## 6005

MALE ORFS X MALE BSPP

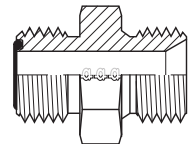

6005-04-02	6005-10-08	6005-20-12
6005-06-04	6005-10-12	6005-20-16
6005-06-06	6005-12-08	6005-20-20
6005-06-08	6005-12-12	6005-24-24
6005-08-04	6005-12-16	
6005-08-06	6005-16-08	
6005-08-08	6005-16-12	
6005-10-06	6005-16-16	

# STEEL INTERNATIONAL ADAPTERS

## 6011

MALE ORFS X MALE BSPT SHORT

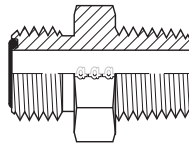

6011-04-04	6011-12-12
6011-06-02	6011-16-16
6011-06-06	6011-20-20
6011-08-08	6011-24-24

## 6068

MALE ORFS X MALE METRIC C/W OR & RR

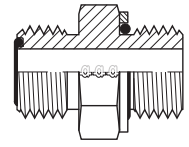

6068-04-10	6068-08-16	6068-12-27
6068-04-12	6068-08-18	6068-16-33
6068-04-14	6068-10-18	
6068-06-12	6068-10-22	
6068-06-14	6068-12-22	
6068-06-16	6068-12-26	

## 6058

45° MALE ORFS X MALE BSPP ADJUSTABLE ELBOW

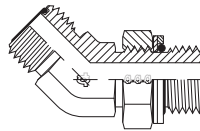

6058-04-02	6058-08-06	6058-16-16
6058-04-04	6058-08-08	
6058-06-04	6058-10-08	
6058-06-06	6058-12-12	

## 6069

90° MALE ORFS X MALE METRIC ADJUSTABLE ELBOW

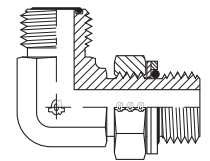

6069-04-10	6069-08-16	6069-20-33
6069-04-12	6069-08-18	
6069-04-14	6069-10-18	
6069-06-14	6069-10-22	
6069-06-16	6069-12-27	
6069-06-18	6069-16-33	

## 6059

90° ORFS X MALE BSPP ADJUSTABLE ELBOW

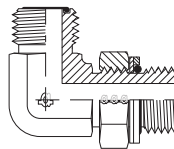

6059-04-02	6059-10-08	6059-20-20
6059-04-04	6059-12-08	6059-20-24
6059-06-04	6059-12-12	6059-24-20
6059-06-06	6059-12-16	6059-24-24
6059-06-08	6059-16-12	
6059-08-04	6059-16-16	
6059-08-06	6059-16-20	
6059-08-08	6059-20-16	

## 6158

MALE ORFS X MALE BSPP ADJUSTABLE RUN TEE

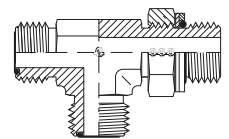

6158-06-06-04	6158-10-10-08
6158-06-06-06	6158-12-12-12
6158-08-08-06	6158-12-12-16
6158-08-08-08	6158-16-16-16

# STEEL INTERNATIONAL ADAPTERS

## 6159

MALE ORFS X MALE BSPP  
ADJUSTABLE BRANCH TEE

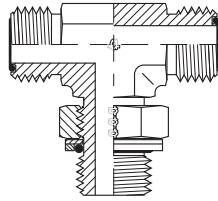

6159-04-04-02	6159-08-08-06
6159-04-04-04	6159-08-08-08
6159-06-06-04	6159-10-10-08
6159-06-06-06	

## 6237

MALE ORFS X MALE KOMATSU

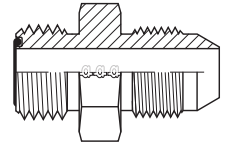

6237-04-14	6237-12-30
6237-06-18	6237-16-33
6237-08-22	
6237-10-24	

## 6168

MALE ORFS X MALE METRIC RUN  
TEE

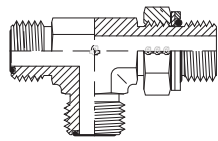

6168-04-04-10	6168-08-08-16
6168-04-04-12	6168-08-08-18
6168-06-06-14	6168-10-10-22
6168-06-06-16	

## 6247

MALE ORFS X MALE KOBELCO

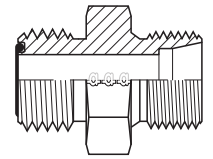

6247-12-22-30	6247-16-28-36
6247-12-28-36	6247-16-35-45

## 6169

MALE ORFS X MALE METRIC  
BRANCH TEE

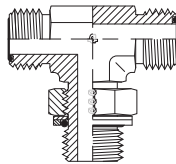

6169-04-04-10	6169-08-08-16	6169-10-10-22
6169-06-06-14	6169-08-08-18	

## 6337

MALE ORFS X MALE JIS

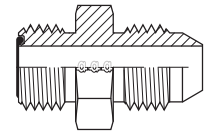

6337-04-04	6337-08-08
6337-06-06	

## 6220

MALE ORFS X FEMALE JIS

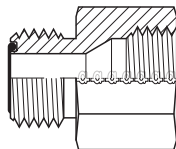

6220-04-04	6220-08-08
6220-06-06	6220-12-12

## 6605

MALE ORFS X DIN LIGHT DUTY

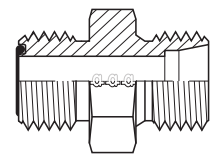

6605-04-L06-12	6605-06-L12-18	6605-12-L12-18
6605-04-L08-14	6605-08-L10-16	6605-12-L15-22
6605-06-L08-14	6605-08-L12-18	6605-12-L18-26
6605-06-L10-16	6605-08-L15-22	6605-16-L22-30

## 6230

MALE ORFS X FEMALE KOMATSU

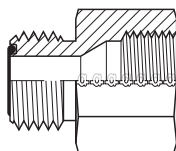

6230-04-14	6230-08-22	6230-12-30
6230-06-18	6230-10-24	6230-16-33

# STEEL INTERNATIONAL ADAPTERS

## 6606

MALE ORFS X DIN HEAVY DUTY

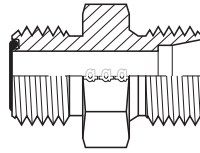

6606-04-S06-14	6606-08-S12-20	6606-12-S25-36
6606-04-S08-16	6606-08-S14-22	6606-16-S25-36
6606-06-S08-16	6606-10-S12-20	6606-16-S30-42
6606-06-S10-18	6606-12-S20-30	

## 6620

MALE JIC X FEMALE ORFS SWIVEL

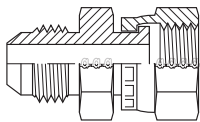

6620-04-04	6620-10-10	6620-24-24
6620-04-06	6620-10-12	
6620-06-04	6620-12-12	
6620-06-06	6620-12-16	
6620-06-08	6620-16-16	
6620-08-08	6620-20-20	

## 6621

MALE ORFS X FEMALE JIC SWIVEL

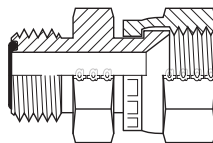

6621-04-04	6621-12-12
6621-06-06	6621-16-16
6621-08-08	6621-20-20
6621-10-10	6621-24-24

## 6622

MALE ORFS X MALE JIC

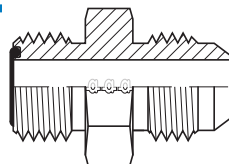

6622-04-04	6622-08-08	6622-20-20
6622-06-04	6622-10-10	6622-24-24
6622-06-06	6622-12-12	
6622-06-08	6622-16-16	

## 9000

MALE BSPP NIPPLE

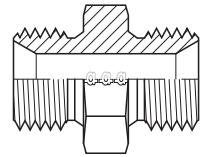

9000-02-02	9000-12-08	9000-24-10
9000-04-02	9000-12-10	9000-24-12
9000-04-04	9000-12-12	9000-24-16
9000-06-02	9000-16-04	9000-24-20
9000-06-04	9000-16-06	9000-24-24
9000-06-06	9000-16-08	9000-32-12
9000-08-02	9000-16-10	9000-32-16
9000-08-04	9000-16-12	9000-32-20
9000-08-06	9000-16-16	9000-32-24
9000-08-08	9000-20-06	9000-32-32
9000-10-04	9000-20-08	9000-40-24
9000-10-06	9000-20-10	9000-40-32
9000-10-08	9000-20-12	9000-40-40
9000-10-10	9000-20-16	9000-48-32
9000-12-04	9000-20-20	9000-48-40
9000-12-06	9000-24-08	9000-48-48

## 9000ES

MALE BSPP ES SEAL X MALE BSPP CHAMFERED

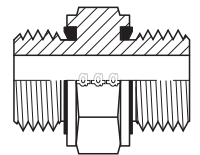

9000-02-02ES	9000-08-08ES	9000-20-12ES
9000-04-04ES	9000-12-06ES	9000-20-16ES
9000-06-04ES	9000-12-08ES	9000-20-20ES
9000-06-06ES	9000-12-12ES	9000-24-08ES
9000-08-04ES	9000-16-12ES	9000-24-20ES
9000-08-06ES	9000-16-16ES	9000-24-24ES

## 9000TP

MALE BSPP TEST PORT ADAPTER

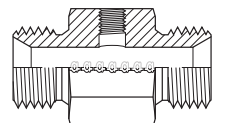

9000TP-04-04-02BSP	9000TP-12-12-02BSP
9000TP-06-06-02BSP	9000TP-12-12-04BSP
9000TP-08-08-02BSP	9000TP-16-16-04BSP
9000TP-08-08-04BSP	9000TP-24-24-04BSP

# STEEL INTERNATIONAL ADAPTERS

## 9001

MALE METRIC NIPPLE

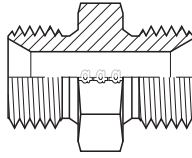

9001-10-10	9001-18-18	9001-24-20
9001-12-10X1.0	9001-20-16	9001-24-22
9001-12-10	9001-20-18	9001-24-24
9001-12-12	9001-20-20	9001-26-18
9001-14-12	9001-22-10X1.0	9001-26-22
9001-14-14	9001-22-14	9001-26-24
9001-16-12	9001-22-16	9001-26-26
9001-16-14	9001-22-18	9001-30-22
9001-16-16	9001-22-20	9001-30X2.0-22
9001-18-12	9001-22-22	9001-30-24
9001-18-14	9001-24-16	9001-30-26
9001-18-16	9001-24-18	9001-30-30

## 9003

BSPP MALE X BSPT MALE

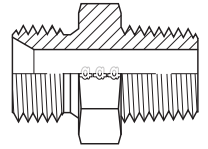

9003-02-02	9003-08-08	9003-16-20
9003-02-04	9003-08-10	9003-16-24
9003-02-06	9003-08-12	9003-16-32
9003-02-08	9003-08-16	9003-20-12
9003-04-02	9003-10-06	9003-20-16
9003-04-04	9003-10-08	9003-20-20
9003-04-06	9003-10-10	9003-20-24
9003-04-08	9003-10-12	9003-20-32
9003-04-12	9003-12-04	9003-24-16
9003-04-16	9003-12-06	9003-24-20
9003-06-02	9003-12-08	9003-24-24
9003-06-04	9003-12-10	9003-24-32
9003-06-06	9003-12-12	9003-32-24
9003-06-08	9003-12-16	9003-32-32
9003-06-10	9003-12-20	9003-40-40
9003-06-12	9003-16-06	9003-48-48
9003-06-16	9003-16-08	
9003-08-02	9003-16-10	
9003-08-04	9003-16-12	
9003-08-06	9003-16-16	

## 9002

MALE JIC X MALE BSPP C/W OR & RR

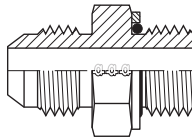

9002-04-02	9002-08-06	9002-16-16
9002-04-04	9002-08-08	9002-16-20
9002-04-06	9002-08-12	9002-20-20
9002-05-04	9002-10-08	9002-20-16
9002-05-06	9002-10-10	9002-24-20
9002-06-02	9002-10-12	9002-24-24
9002-06-04	9002-12-08	9002-32-32
9002-06-06	9002-12-12	
9002-06-08	9002-12-16	
9002-08-04	9002-16-12	

## 9004

MALE BSPP X MALE METRIC

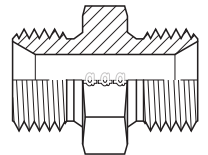

9004-02-10	9004-06-24	9004-12-30
9004-02-12	9004-08-12	9004-12-33X2.0
9004-02-14	9004-08-14	9004-16-18
9004-04-10	9004-08-16	9004-16-22
9004-04-08X1.0	9004-08-18	9004-16-26
9004-04-10X1.0	9004-08-20	9004-16-27X2.0
9004-04-10X1.25	9004-08-22	9004-16-28
9004-04-12	9004-08-24	9004-16-30
9004-04-14	9004-08-26	9004-16-36
9004-04-16	9004-08-27	9004-16-38
9004-04-18	9004-08-28	9004-20-30
9004-04-20	9004-10-22	9004-20-38
9004-04-22	9004-10-26	9004-20-48
9004-04-24	9004-12-16	9004-24-38
9004-06-12	9004-12-18	9004-24-45
9004-06-14	9004-12-20	9004-32-45
9004-06-16	9004-12-22	9004-32-52
9004-06-18	9004-12-24	
9004-06-20	9004-12-26	
9004-06-22	9004-12-27X1.5	

## 9002L

MALE JIC X MALE BSPP LONG C/W OR & RR

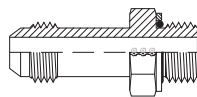

9002L-04-04	9002L-10-08	9002L-20-20
9002L-06-04	9002L-12-12	
9002L-08-06	9002L-12-16	
9002L-08-08	9002L-16-16	

# STEEL INTERNATIONAL ADAPTERS

## 9005

MALE JIC X MALE BSPP

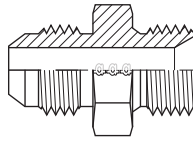

9005-03-04	9005-08-10	9005-16-10
9005-04-02	9005-08-12	9005-16-12
9005-04-04	9005-08-16	9005-16-16
9005-04-06	9005-10-04	9005-16-20
9005-04-08	9005-10-06	9005-16-24
9005-04-12	9005-10-08	9005-16-32
9005-05-02	9005-10-10	9005-20-12
9005-05-04	9005-10-12	9005-20-16
9005-05-06	9005-10-16	9005-20-20
9005-05-08	9005-12-04	9005-20-24
9005-05-10	9005-12-06	9005-24-12
9005-06-02	9005-12-08	9005-24-16
9005-06-04	9005-12-10	9005-24-20
9005-06-06	9005-12-12	9005-24-24
9005-06-08	9005-12-16	9005-24-32
9005-06-10	9005-12-20	9005-32-16
9005-06-12	9005-14-08	9005-32-20
9005-08-04	9005-14-12	9005-32-24
9005-08-06	9005-14-16	9005-32-32
9005-08-08	9005-16-08	9005-32-40

## 9005EL

MALE JIC X MALE BSPP -  
EXTRA LONG NIPPLE

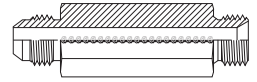

9005EL-04-04	9005EL-08-08
9005EL-06-04	9005EL-12-08
9005EL-06-06	9005EL-12-10
9005EL-08-06	9005EL-12-12

## 9005L

MALE JIC X MALE BSPP -  
LONG NIPPLE

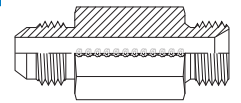

9005L-04-04	9005L-08-06
9005L-06-06	9005L-10-08

## 9006

MALE SAE ORB X MALE BSPP

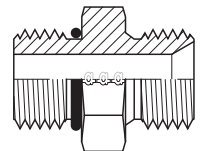

9006-04-02	9006-08-12	9006-16-20
9006-04-04	9006-10-06	9006-20-12
9006-04-06	9006-10-08	9006-20-16
9006-04-08	9006-10-10	9006-20-20
9006-05-04	9006-10-12	9006-20-24
9006-05-06	9006-10-16	9006-24-16
9006-05-08	9006-12-06	9006-24-20
9006-06-04	9006-12-08	9006-24-24
9006-06-06	9006-12-10	9006-24-32
9006-06-08	9006-12-12	9006-32-32
9006-08-04	9006-12-16	
9006-08-06	9006-16-08	
9006-08-08	9006-16-12	
9006-08-10	9006-16-16	

## 9005ES

MALE JIC X MALE BSPP C/W  
ELASTOMERIC SEAL

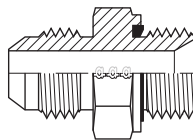

9005ES-04-02	9005ES-08-12	9005ES-20-12
9005ES-04-04	9005ES-08-16	9005ES-20-16
9005ES-04-06	9005ES-10-08	9005ES-20-20
9005ES-04-08	9005ES-10-10	9005ES-20-24
9005ES-05-04	9005ES-10-12	9005ES-24-20
9005ES-06-02	9005ES-12-08	9005ES-24-24
9005ES-06-04	9005ES-12-10	9005ES-24-32
9005ES-06-06	9005ES-12-12	9005ES-32-24
9005ES-06-08	9005ES-12-16	9005ES-32-32
9005ES-06-12	9005ES-12-20	
9005ES-08-04	9005ES-16-12	
9005ES-08-06	9005ES-16-16	
9005ES-08-08	9005ES-16-20	
9005ES-08-10	9005ES-16-24	

# STEEL INTERNATIONAL ADAPTERS

## 9007

MALE BSPP X MALE NPT

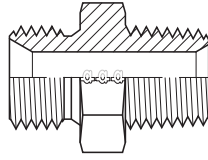

9007-02-02	9007-10-08	9007-24-16
9007-02-04	9007-10-12	9007-24-20
9007-02-06	9007-12-04	9007-24-24
9007-02-08	9007-12-06	9007-24-32
9007-04-02	9007-12-08	9007-32-16
9007-04-04	9007-12-12	9007-32-20
9007-04-06	9007-12-16	9007-32-24
9007-04-08	9007-12-20	9007-32-32
9007-04-12	9007-16-08	9007-32-40
9007-06-02	9007-16-12	9007-32-48
9007-06-04	9007-16-16	9007-40-32
9007-06-06	9007-16-20	9007-40-40
9007-06-08	9007-16-24	9007-40-48
9007-06-12	9007-16-32	9007-48-48
9007-06-16	9007-20-12	9007-64-64
9007-08-04	9007-20-16	
9007-08-06	9007-20-20	
9007-08-08	9007-20-24	
9007-08-12	9007-20-32	
9007-08-16	9007-24-12	

## 9008

MALE BSPT X MALE NPT NIPPLE

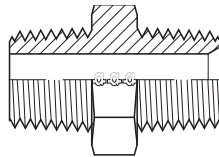

9008-02-02	9008-06-06	9008-32-32
9008-02-04	9008-08-08	9008-40-40
9008-04-02	9008-12-12	9008-48-48
9008-04-04	9008-16-16	
9008-04-06	9008-20-20	
9008-06-04	9008-24-24	

## 9009

MALE JIC X FEMALE BSP

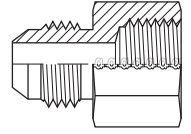

9009-04-02	9009-08-06	9009-16-20
9009-04-04	9009-08-08	9009-20-16
9009-04-06	9009-08-12	9009-20-20
9009-06-02	9009-10-10	9009-20-24
9009-06-04	9009-12-08	9009-24-20
9009-06-06	9009-12-12	9009-24-24
9009-06-08	9009-12-16	9009-32-32
9009-08-02	9009-16-16	

## 9010

MALE BSPT NIPPLE

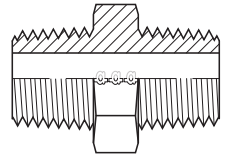

9010-02-02	9010-08-08	9010-20-16
9010-04-02	9010-10-10	9010-20-20
9010-04-04	9010-12-06	9010-24-20
9010-06-02	9010-12-08	9010-24-24
9010-06-04	9010-12-12	9010-32-24
9010-06-06	9010-16-08	9010-32-32
9010-08-04	9010-16-12	9010-40-40
9010-08-06	9010-16-16	9010-48-48

## 9011

MALE JIC X MALE BSPT

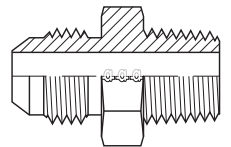

9011-02-04	9011-08-06	9011-16-12
9011-04-02	9011-08-08	9011-16-16
9011-04-04	9011-08-12	9011-16-20
9011-04-06	9011-08-16	9011-20-16
9011-05-02	9011-10-06	9011-20-20
9011-05-04	9011-10-08	9011-20-24
9011-05-06	9011-10-10	9011-24-20
9011-06-02	9011-10-12	9011-24-24
9011-06-04	9011-12-08	9011-24-32
9011-06-06	9011-12-12	9011-32-32
9011-06-08	9011-12-16	
9011-08-04	9011-14-12	



# STEEL INTERNATIONAL ADAPTERS

## 9015

MALE BSPP X FEMALE BSPP  
SWIVEL

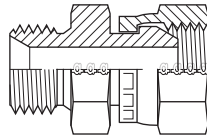

9015-02-02	9015-08-12	9015-16-12
9015-02-04	9015-08-16	9015-16-16
9015-02-06	9015-10-04	9015-16-20
9015-04-02	9015-10-06	9015-16-24
9015-04-04	9015-10-08	9015-20-12
9015-04-06	9015-10-10	9015-20-16
9015-04-08	9015-10-12	9015-20-20
9015-04-12	9015-10-16	9015-20-24
9015-06-04	9015-12-04	9015-20-32
9015-06-06	9015-12-06	9015-24-16
9015-06-08	9015-12-08	9015-24-20
9015-06-10	9015-12-10	9015-24-24
9015-06-12	9015-12-12	9015-24-32
9015-06-16	9015-12-16	9015-32-24
9015-08-04	9015-12-20	9015-32-32
9015-08-06	9015-12-24	
9015-08-08	9015-16-08	
9015-08-10	9015-16-10	

## 9018

MALE METRIC X FEMALE BSPP  
SWIVEL

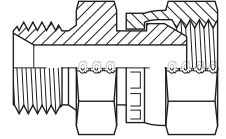

9018-12-04	9018-20-08	9018-30X1.5-08
9018-14-04	9018-22-08	
9018-14-06	9018-22-12	
9018-16-06	9018-26-08	
9018-18-06	9018-26-12	
9018-18-08	9018-30X1.5-06	

## 9019

MALE BSPP X FEMALE METRIC  
SWIVEL

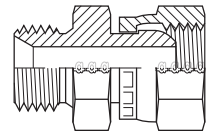

9019-04-L06-12	9019-06-L12-18	9019-08-S12-20
9019-04-L08-14	9019-06-S12-20	9019-08-S16-24
9019-04-L10-16	9019-08-L08-14	9019-10-L15-22
9019-06-L06-12	9019-08-L10-16	9019-12-L12-18
9019-06-L08-14	9019-08-L12-18	9019-12-L15-22
9019-06-L10-16	9019-08-L15-22	9019-12-S12-20

## 9015TP

BSPP TEST PORT TEE

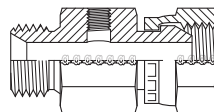

9015TP-02-02-B02	9015TP-12-12-B04
9015TP-04-04-B02	9015TP-16-16-B02
9015TP-06-06-B02	9015TP-16-16-B04
9015TP-06-06-B04	9015TP-20-20-B02
9015TP-08-08-B02	9015TP-20-20-B04
9015TP-12-12-B02	

## 9020

MALE JIC X FEMALE JIC SWIVEL

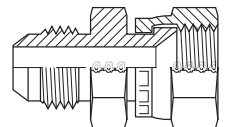

9020-04-04	9020-06-10	9020-12-12
9020-04-06	9020-06-12	9020-12-14
9020-04-08	9020-08-04	9020-12-16
9020-04-10	9020-08-05	9020-12-24
9020-04-12	9020-08-06	9020-16-12
9020-05-04	9020-08-08	9020-16-16
9020-05-05	9020-08-10	9020-16-20
9020-05-06	9020-08-12	9020-20-16
9020-05-08	9020-10-08	9020-20-20
9020-05-12	9020-10-10	9020-20-24
9020-06-04	9020-10-12	9020-24-24
9020-06-05	9020-12-04	9020-32-32
9020-06-06	9020-12-08	
9020-06-08	9020-12-10	

## 9017

FEMALE JIC (SWIVEL) X MALE NPT

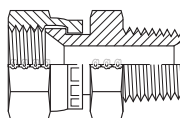

9017-04-02	9017-08-08	9017-20-20
9017-04-04	9017-10-08	9017-24-20
9017-05-04	9017-12-12	9017-24-24
9017-06-04	9017-12-16	
9017-06-06	9017-16-12	
9017-08-06	9017-16-16	

# STEEL INTERNATIONAL ADAPTERS

## 9020C

FIXED MALE JIC X FEMALE JIC

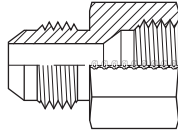

9020C-06-04	9020C-12-10	9020C-32-24
9020C-08-06	9020C-16-12	
9020C-10-08	9020C-20-16	
9020C-12-08	9020C-24-20	

## 9020TP

M.JIC X F.JIC 1/8" BSPP TEST

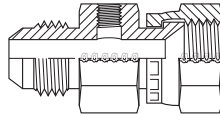

9020TP-04-04-02*	9020TP-12-12-02*
9020TP-08-08-02*	9020TP-16-16-02*
9020TP-08-08-10X1	
9020TP-10-10-02*	

## 9021

MALE BSPP X FEMALE JIC SWIVEL

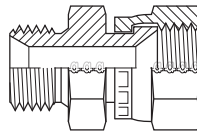

9021-02-04	9021-08-06	9021-12-20
9021-04-04	9021-08-08	9021-16-12
9021-04-05	9021-08-10	9021-16-16
9021-04-06	9021-08-12	9021-16-20
9021-04-08	9021-08-16	9021-20-16
9021-06-04	9021-10-08	9021-20-20
9021-06-05	9021-10-10	9021-20-24
9021-06-06	9021-10-12	9021-24-24
9021-06-08	9021-12-06	9021-32-24
9021-06-10	9021-12-08	9021-32-32
9021-06-12	9021-12-10	
9021-06-16	9021-12-12	
9021-08-04	9021-12-14	
9021-08-05	9021-12-16	

## 9022

MALE JIC X FEMALE METRIC SWIVEL

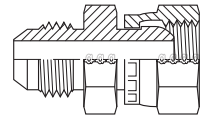

9022-04-L06-12	9022-06-L15-22	9022-10-L12-18
9022-04-L08-14	9022-06-S12-20	9022-10-L15-22
9022-05-L06-12	9022-08-L10-16	9022-10-S12-20
9022-06-L08-14	9022-08-L12-18	9022-12-S20-30
9022-06-L10-16	9022-08-L15-22	
9022-06-L12-18	9022-08-S12-20	

## 9022F

MALE JIC X FEMALE FLAT FACE METRIC (FIXED)

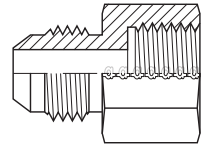

9022F-08-18
9022F-08-22

## 9022FC

MALE JIC X FEMALE FLAT FACE METRIC SHORT (SOLID)

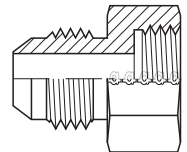

9022FC-04-12	9022FC-08-18
9022FC-04-14	9022FC-08-20
9022FC-06-16	9022FC-08-22
9022FC-06-18	

## 9023

MALE NPT X FEMALE BSPP SWIVEL

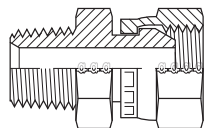

9023-02-02	9023-06-08	9023-16-12
9023-04-02	9023-08-06	9023-16-16
9023-04-04	9023-08-08	
9023-04-06	9023-12-08	
9023-06-04	9023-12-12	
9023-06-06	9023-12-16	

# STEEL INTERNATIONAL ADAPTERS

## 9024

MALE METRIC-FEMALE JIC  
SWIVEL

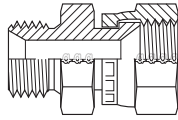

9024-12-05	9024-18-08	9024-22-08
9024-14-06	9024-18-10	9024-22-10
9024-16-06	9024-20-06	
9024-16-08	9024-20-08	
9024-16-10	9024-20-10	
9024-18-06	9024-22-06	

## 9026

FEMALE JIC (SWIVEL) UNION

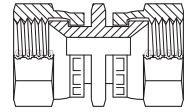

9026-04-04	9026-08-08	9026-16-16
9026-05-04	9026-10-08	9026-20-16
9026-05-05	9026-10-10	9026-20-20
9026-06-04	9026-12-08	9026-24-24
9026-06-05	9026-12-10	9026-32-32
9026-06-06	9026-12-12	
9026-08-04	9026-14-12	
9026-08-06	9026-16-12	

## 9024S

MALE METRIC (SEALED) X FEMALE  
JIC

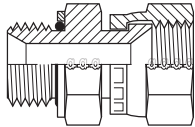

9024S-12-05	9024S-18-08	9024S-22-10
9024S-14-06	9024S-18-10	
9024S-16-06	9024S-20-08	
9024S-16-08	9024S-20-10	
9024S-16-10	9024S-22-06	
9024S-18-06	9024S-22-08	

## 9027

FEMALE BSPP X FEMALE JIC  
SWIVEL

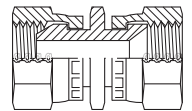

9027-04-04	9027-06-08	9027-12-16
9027-04-05	9027-08-06	9027-16-12
9027-04-06	9027-08-08	9027-16-16
9027-06-04	9027-10-10	9027-20-20
9027-06-05	9027-12-08	
9027-06-06	9027-12-12	

## 9025

FEMALE BSPP (SWIVEL) UNION

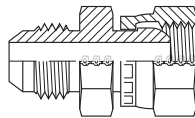

9025-02-02	9025-12-04	9025-20-20
9025-04-02	9025-12-08	9025-24-16
9025-04-04	9025-12-10	9025-24-24
9025-06-04	9025-12-12	9025-32-24
9025-06-06	9025-16-08	9025-32-32
9025-08-04	9025-16-10	
9025-08-06	9025-16-12	
9025-08-08	9025-16-16	
9025-10-08	9025-20-12	
9025-10-10	9025-20-16	

## 9028

BSPP COUNTERSUNK SEALED  
PLUG

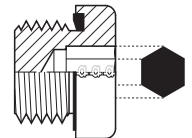

9028-02	9028-12	9028-32
9028-04	9028-16	
9028-06	9028-20	
9028-08	9028-24	

# STEEL INTERNATIONAL ADAPTERS

## 9029

METRIC COUNTERSUNK SEALED PLUG

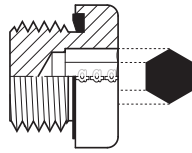

9029-08X1.0	9029-20X1.5	9029-42X2.0
9029-10X1.0	9029-22X1.5	9029-48X2.0
9029-12X1.5	9029-24X1.5	
9029-14X1.5	9029-26X1.5	
9029-16X1.5	9029-27X2.0	
9029-18X1.5	9029-33X2.0	

## 9029ISO

METRIC ISO 6149 COUNTERSUNK PLUG

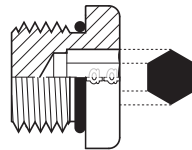

9029ISO-08X1.0	9029ISO-20X1.5	9029ISO-48X2.0
9029ISO-10X1.0	9029ISO-22X1.5	9029ISO-60X2.0
9029ISO-12X1.5	9029ISO-27X2.0	
9029ISO-14X1.5	9029ISO-30X2.0	
9029ISO-16X1.5	9029ISO-33X2.0	
9029ISO-18X1.5	9029ISO-42X2.0	

## 9029

METRIC COUNTERSUNK SEALED PLUG

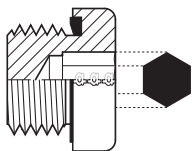

9029-12X1.5A	9029-36X1.5A	9029-48X1.5A
9029-20X1.5A	9029-36X2.0A	
9029-22X1.5A	9029-38X1.5A	
9029-30X2.0A	9029-42X1.5A	

## 9030

MALE BSPP HEX PLUG

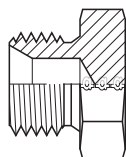

9030-02	9030-16	9030-64
9030-04	9030-20	
9030-06	9030-24	
9030-08	9030-32	
9030-10	9030-40	
9030-12	9030-48	

## 9030M

METRIC HEX PLUG

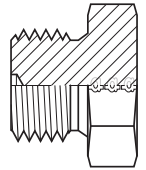

9030M-08X1.0	9030M-16X1.5	9030M-30X1.5
9030M-10X1.0	9030M-18X1.5	9030M-36X2.0
9030M-10X1.5	9030M-20X1.5	
9030M-12X1.0	9030M-22X1.5	
9030M-12X1.5	9030M-24X1.5	
9030M-14X1.5	9030M-26X1.5	

## 9030T

BSPT HEX PLUG

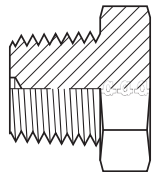

9030T-02	9030T-10	9030T-24
9030T-04	9030T-12	9030T-32
9030T-06	9030T-16	9030T-40
9030T-08	9030T-20	9030T-48

## 9030TCSP

BSPT COUNTERSUNK PLUG

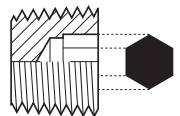

9030TCSP-02	9030TCSP-06	9030TCSP-12
9030TCSP-04	9030TCSP-08	9030TCSP-16

## 9031

MALE BSPT X FEMALE BSPT BUSHING

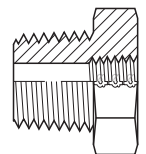

9031-04-02	9031-12-08	9031-32-32
9031-06-02	9031-16-08	
9031-06-04	9031-16-12	
9031-08-04	9031-20-08	
9031-08-06	9031-24-16	
9031-12-06	9031-32-24	

# STEEL INTERNATIONAL ADAPTERS

## 9032

MALE BSPT X FEMALE BSP

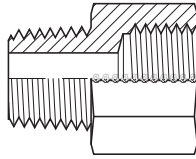

9032-02-02	9032-08-08	9032-20-16
9032-02-04	9032-12-04	9032-20-20
9032-04-02	9032-12-06	9032-24-20
9032-04-04	9032-12-08	9032-32-16
9032-04-06	9032-12-12	
9032-06-02	9032-16-08	
9032-06-04	9032-16-12	
9032-06-06	9032-16-16	

## 9034

MALE BSPP X FEMALE BSPT

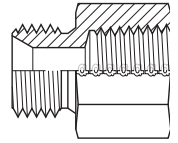

9034-04-02	9034-06-04	9034-08-08
9034-04-04	9034-06-06	9034-12-12

## 9035

MALE BSPP X FEMALE NPT

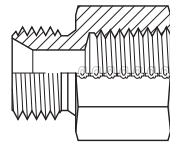

9035-02-02	9035-10-08	9035-24-16
9035-02-04	9035-12-04	9035-24-20
9035-04-02	9035-12-06	9035-24-24
9035-04-04	9035-12-08	9035-24-32
9035-04-06	9035-12-12	9035-32-12
9035-04-08	9035-12-16	9035-32-24
9035-06-02	9035-16-04	9035-32-32
9035-06-04	9035-16-06	9035-40-24
9035-06-06	9035-16-08	9035-40-32
9035-06-08	9035-16-12	9035-40-40
9035-08-02	9035-16-16	9035-40-48
9035-08-04	9035-20-08	9035-48-32
9035-08-06	9035-20-12	9035-48-48
9035-08-08	9035-20-16	
9035-08-12	9035-20-20	
9035-10-06	9035-24-12	

## 9032S

MALE BSPT X FEMALE BSPP SWIVEL

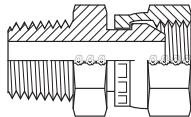

9032S-04-04	9032S-08-06
9032S-06-06	9032S-08-08

## 9033

FEMALE BSPP CAP

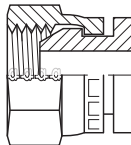

9033-02	9033-10	9033-24
9033-04	9033-12	9033-32
9033-06	9033-16	
9033-08	9033-20	

## 9033F

FIXED FEMALE BSPP CAP

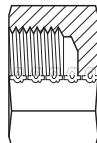

9033F-06	9033F-16	9033F-32
9033F-08	9033F-20	

## 9035S

MALE BSPP X FEMALE NPT COMES W/ WASHER & O-RING

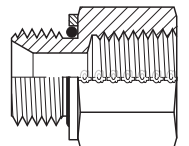

9035S-02-02	9035S-08-08	9035S-32-32
9035S-04-02	9035S-12-08	
9035S-04-04	9035S-12-12	
9035S-06-04	9035S-16-16	
9035S-06-06	9035S-20-20	
9035S-08-06	9035S-24-24	

# STEEL INTERNATIONAL ADAPTERS

## 9036

MALE BSPP X FEMALE SAE O-RING BOSS (SOLID)

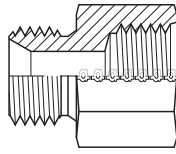

9036-02-04	9036-06-08	9036-12-16
9036-04-04	9036-08-08	9036-16-16
9036-04-05	9036-08-10	9036-20-20
9036-04-06	9036-08-16	9036-20-24
9036-06-05	9036-10-10	9036-24-24
9036-06-06	9036-12-12	9036-32-24

## 9038ES

MALE BSPP X FEMALE BSP BUSHING SEALED

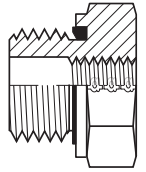

9038-06-02ES	9038-20-08ES	9038-32-20ES
9038-08-04ES	9038-20-12ES	
9038-12-04ES	9038-20-16ES	
9038-12-06ES	9038-24-08ES	
9038-12-08ES	9038-24-12ES	
9038-16-04ES	9038-24-16ES	

## 9037

MALE NPT X FEMALE BSP

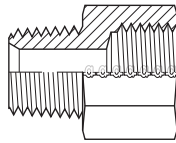

9037-02-02	9037-12-06	9037-24-20
9037-02-04	9037-12-08	9037-24-24
9037-04-02	9037-12-12	9037-32-16
9037-04-04	9037-12-16	9037-32-20
9037-04-06	9037-16-04	9037-32-32
9037-04-08	9037-16-06	9037-40-40
9037-06-04	9037-16-08	9037-48-32
9037-06-06	9037-16-12	9037-48-48
9037-08-04	9037-16-16	
9037-08-06	9037-20-08	
9037-08-08	9037-20-20	
9037-12-04	9037-24-16	

## 9039

MALE BSPP X FEMALE BSP EXTENDED BUSHING

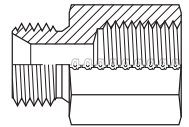

9039-02-02	9039-08-08	9039-16-32
9039-02-04	9039-08-10	9039-20-20
9039-02-06	9039-08-12	9039-20-32
9039-02-08	9039-08-16	9039-24-20
9039-04-02	9039-08-20	9039-24-24
9039-04-04	9039-10-08	9039-32-24
9039-04-06	9039-12-08	9039-32-32
9039-04-08	9039-12-10	
9039-04-10	9039-12-12	
9039-04-12	9039-12-16	
9039-06-04	9039-12-20	
9039-06-06	9039-12-24	
9039-06-08	9039-16-12	
9039-06-12	9039-16-16	
9039-06-16	9039-16-20	
9039-08-06	9039-16-24	

## 9038

MALE BSPP X FEMALE BSP BUSHING

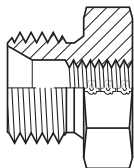

9038-06-02	9038-16-08	9038-24-12
9038-08-02	9038-16-10	9038-24-16
9038-08-04	9038-20-06	9038-32-08
9038-10-06	9038-20-08	9038-32-12
9038-12-04	9038-20-12	9038-32-16
9038-12-06	9038-20-16	9038-32-20
9038-16-04	9038-24-06	9038-32-24
9038-16-06	9038-24-08	9038-40-32

## 9039ES

MALE BSPP X FEMALE BSP EXTENDED BUSHING SEALED

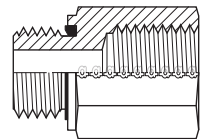

9039-02-04ES	9039-06-04ES	9039-24-20ES
9039-02-06ES	9039-06-06ES	9038-24-08ES
9039-04-02ES	9039-08-12ES	9038-24-12ES
9039-04-06ES	9039-12-16ES	9038-24-16ES

# STEEL INTERNATIONAL ADAPTERS

## 9040

MALE BSPP X MALE BSPP  
BULKHEAD

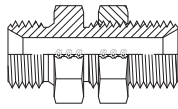

9040-02-02	9040-12-12	9040-04-06L-1.85"
9040-04-04	9040-12-16	9040-06-06L-2.5"
9040-04-06	9040-16-12	9040-08-06L-2.75"
9040-06-04	9040-16-16	9040-08-06L-2.87"
9040-06-06	9040-20-20	9040-08-08L-2.75"
9040-06-08	9040-20-24	9040-16-16L-3.25"
9040-08-06	9040-24-24	
9040-08-08	9040-32-32	
9040-08-12	9040-40-40	
9040-10-10	9040-04-04L-2.25"	
9040-12-06	9040-04-04L-2.5"	
9040-12-08	9040-04-04L-3.14"	

## 9040M

MALE BSPP X MALE METRIC  
BULKHEAD

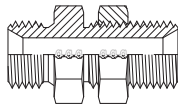

9040M-06-14	9040M-06-18	9040M-08-22
9040M-06-16	9040M-08-S08-16	

## 9041

BSPP BULKHEAD LOCKNUT

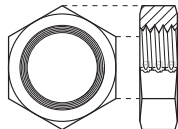

9041-02	9041-10	9041-24
9041-04	9041-12	9041-32
9041-06	9041-16	9041-40
9041-08	9041-20	

## 9042

MALE BSPT X FEMALE NPT

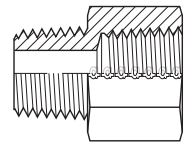

9042-02-02	9042-12-04	9042-20-40
9042-02-04	9042-12-06	9042-24-16
9042-04-02	9042-12-08	9042-24-20
9042-04-04	9042-12-12	9042-24-24
9042-04-06	9042-16-04	9042-32-32
9042-06-04	9042-16-12	9042-48-48
9042-06-02	9042-16-16	
9042-06-06	9042-20-12	
9042-08-04	9042-20-16	
9042-08-08	9042-20-20	

## 9043

BSP (SOLID) X BSP (SOLID)  
COUPLING

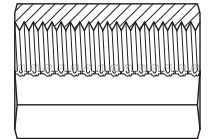

9043-02-02	9043-12-04	9043-20-20
9043-04-02	9043-12-06	9043-24-16
9043-04-04	9043-12-08	9043-24-24
9043-06-02	9043-12-10	9043-32-24
9043-06-04	9043-12-12	9043-32-32
9043-06-06	9043-16-06	9043-40-40
9043-08-02	9043-16-08	9043-48-48
9043-08-06	9043-16-12	9043-64-64
9043-08-08	9043-16-16	
9043-10-06	9043-20-08	
9043-10-08	9043-20-12	
9043-10-10	9043-20-16	

# STEEL INTERNATIONAL ADAPTERS

## 9043M

FEMALE METRIC COUPLING

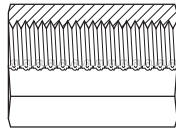

9043M-12-12	9043M-16-16	9043M-22-22
9043M-14-10	9043M-18-18	9043M-30-30
9043M-14-14	9043M-20-20	
9043M-16-12	9043M-22-16	

## 9044

FEMALE BSP X FEMALE NPT

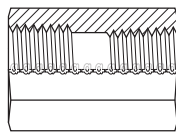

9044-02-02	9044-08-08	9044-20-20
9044-04-04	9044-12-08	9044-24-24
9044-06-04	9044-12-12	9044-32-32
9044-06-06	9044-12-16	9044-40-40
9044-08-04	9044-16-16	9044-48-48
9044-08-06	9044-20-16	

## 9045

90° MALE BSPP X FEMALE BSPP (SWIVEL) ELBOW

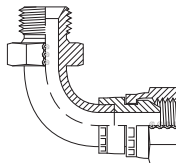

9045-04-04	9045-12-12	9045-32-32
9045-06-06	9045-16-16	
9045-08-08	9045-20-20	
9045-10-10	9045-24-24	

## 9046

90° FEMALE BSPP (SWIVEL) X MALE BSPP ADJ. ELBOW

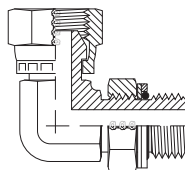

9046-04-04	9046-08-08	9046-16-16
9046-06-06	9046-12-12	

## 9047

45° MALE BSPP X FEMALE BSPP (SWIVEL) TUBE ELBOW

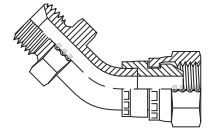

9047-04-04	9047-12-12
9047-06-06	9047-16-16
9047-08-08	9047-20-20
9047-10-10	

## 9048

45° MALE BSPP X FEMALE BSPP (SWIVEL) FORGED ELBOW

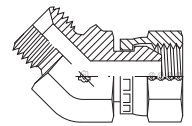

9048-04-04	9048-08-08	9048-16-16
9048-06-06	9048-12-12	

## 9050

90° FEMALE BSPP (SWIVEL) X FEMALE BSPP (SWIVEL) ELBOW

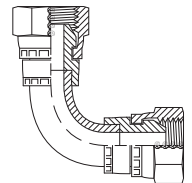

9050-04-04	9050-12-12
9050-06-06	9050-16-16
9050-08-08	9050-20-20
9050-10-10	9050-24-24

## 9051

45° MALE BSPP X ADJ. MALE BSPP ELBOW

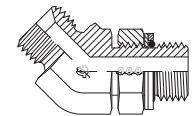

9051-04-04	9051-08-08
9051-06-04	9051-12-08
9051-06-06	9051-12-12
9051-08-06	9051-16-16



# STEEL INTERNATIONAL ADAPTERS

## 9052

90° MALE BSPP X ADJ. MALE BSPP ELBOW

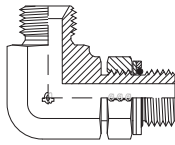

9052-04-04	9052-06-08	9052-12-08
9052-04-06	9052-08-06	9052-12-12
9052-06-04	9052-08-08	9052-16-16
9052-06-06	9052-08-12	9052-20-20

## 9056

90° MALE JIC X FEMALE BSPP (SWIVEL) ELBOW

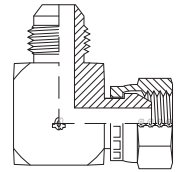

9056-04-04	9056-08-06	9056-12-12
9056-06-06	9056-08-08	9056-16-16

## 9053

45° FEMALE BSPP (SWIVEL) X FEMALE BSPP (SWIVEL) ELBOW

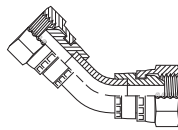

9053-04-04	9053-12-12
9053-06-06	9053-16-16
9053-08-08	9053-20-20
9053-10-10	

## 9057

90° MALE BSPP X MALE BSPT ELBOW

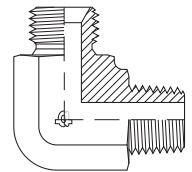

9057-02-02	9057-06-08*	9057-16-16
9057-04-02	9057-08-06	
9057-04-04	9057-08-08	
9057-04-06	9057-10-10*	
9057-06-04	9057-12-12	
9057-06-06	9057-12-16*	

## 9054

45° MALE BSPP X MALE BSPT ELBOW

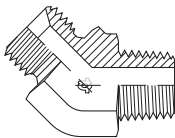

9054-04-02	9054-06-06	9054-16-16
9054-04-04	9054-08-06	
9054-04-06	9054-08-08	
9054-06-04	9054-12-12	

## 9058

45° MALE JIC X MALE BSPP ADJ. ELBOW

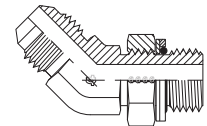

9058-04-02	9058-08-06	9058-12-12
9058-04-04	9058-08-08	9058-16-16
9058-06-04	9058-10-08	
9058-06-06	9058-12-08	

## 9055

90° MALE BSPP ELBOW

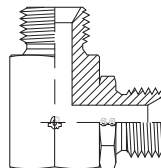

9055-02-02	9055-08-08	9055-16-12
9055-04-04	9055-10-10	9055-16-16
9055-06-04	9055-12-08	9055-20-20
9055-06-06	9055-12-10*	9055-24-24
9055-08-06	9055-12-12	9055-32-32

## 9059

90° MALE JIC X MALE BSPP ADJ. ELBOW

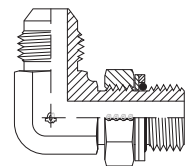

9059-04-02	9059-08-04	9059-12-12
9059-04-04	9059-08-06	9059-12-16
9059-04-06	9059-08-08	9059-16-12
9059-05-04	9059-08-12	9059-16-16
9059-05-06	9059-10-06	9059-16-20
9059-06-04	9059-10-08	9059-20-16
9059-06-06	9059-10-12	9059-20-20
9059-06-08	9059-12-08	9059-24-24

# STEEL INTERNATIONAL ADAPTERS

## 9059L

90° MALE JIC X MALE BSPP ADJ.  
LONG ELBOW

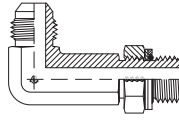

9059L-06-06  
9059L-08-06

9059L-08-08

## 9060

90° MALE BSPP X FEMALE BSPP  
(SWIVEL) ELBOW

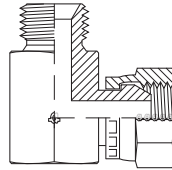

9060-02-02

9060-08-06

9060-16-12

9060-04-04

9060-08-08

9060-16-16

9060-04-06

9060-10-10

9060-20-20

9060-06-04

9060-12-08

9060-24-24

9060-06-06

9060-12-12

9060-32-32

9060-06-08

9060-12-16\*

## 9061

90° MALE BSPP X FEMALE JIC  
(SWIVEL) ELBOW

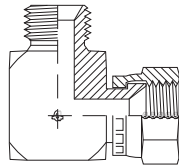

9061-04-04

9061-08-06

9061-12-12

9061-04-06

9061-08-08

9061-06-06

9061-08-10

9061-06-08

9061-10-10

## 9062

90° MALE BSPP X FEMALE BSPP  
(SWIVEL) ELBOW

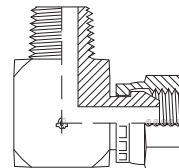

9062-02-02

9062-08-08

9062-04-04

9062-12-12

9062-06-04

9062-16-16

9062-06-06

## 9063

90° MALE JIC X MALE BSPT  
ELBOW

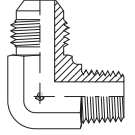

9063-04-02

9063-08-06

9063-20-20

9063-04-04

9063-08-08

9063-24-24

9063-05-02

9063-10-08

9063-32-32

9063-05-04

9063-12-08

9063-05-06

9063-12-12

9063-06-04

9063-12-16

9063-06-06

9063-16-12

9063-06-08

9063-16-16

## 9064

45° MALE JIC X MALE BSPT  
ELBOW

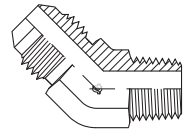

9064-04-02

9064-08-06

9064-16-12

9064-04-04

9064-08-08

9064-16-16

9064-06-04

9064-10-08

9064-20-20

9064-06-06

9064-12-12

## 9065

90° MALE JIC X MALE BSPP  
ELBOW

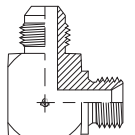

9065-04-04

9065-08-08

9065-12-16

9065-05-04

9065-10-08

9065-16-16

9065-06-04

9065-10-12

9065-20-20

9065-06-06

9065-12-10

9065-08-06

9065-12-12

## 9066

45° MALE JIC X MALE METRIC ADJ  
ELBOW

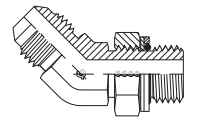

9066-04-10

9066-08-16

9066-12-22

9066-04-12

9066-08-18

9066-12-27

9066-06-14

9066-10-18

9066-16-33

9066-06-16

9066-10-22

# STEEL INTERNATIONAL ADAPTERS

## 9067

MALE JIC X MALE METRIC

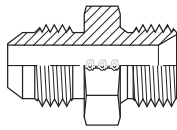

9067-02-10	9067-08-14	9067-10-26
9067-04-12	9067-08-16	9067-12-16
9067-04-14	9067-08-18	9067-12-24
9067-06-12	9067-08-20	9067-12-26
9067-06-14	9067-08-22	9067-12-27X1.5
9067-06-16	9067-10-14	
9067-06-18	9067-10-16	
9067-06-20	9067-10-18	
9067-06-22	9067-10-20	
9067-08-12	9067-10-22	

## 9068

MALE JIC X MALE METRIC COMES W/ WASHER & O-RING

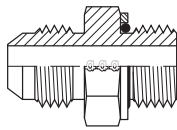

9068-04-10	9068-08-14	9068-16-27
9068-04-12	9068-08-16	9068-16-33
9068-04-14	9068-08-18	9068-20-33
9068-05-12	9068-08-22	9068-20-42
9068-05-16	9068-10-18	9068-24-48
9068-06-12	9068-10-20	
9068-06-14	9068-10-22	
9068-06-16	9068-12-22	
9068-06-18	9068-12-26	
9068-08-12	9068-12-27	

## 9069

90° MALE JIC X MALE METRIC ADJ ELBOW

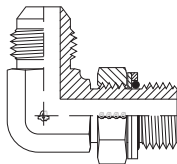

9069-04-10	9069-08-16	9069-12-30X1.5
9069-04-12	9069-08-18	9069-16-27
9069-04-14	9069-08-20	9069-16-33
9069-05-10	9069-08-22	9069-20-42
9069-05-12	9069-10-18	9069-24-48
9069-05-14	9069-10-20	
9069-06-12	9069-10-22	
9069-06-14	9069-12-22	
9069-06-16	9069-12-26	
9069-06-18	9069-12-27	

## 9069L

90° MALE JIC X MALE METRIC ADJ. LONG ELBOW

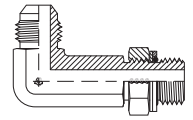

9069L-08-18
9069L-10-22

## 9070

90° MALE BSPP X MALE NPT ELBOW

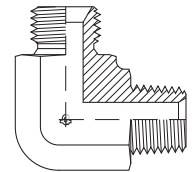

9070-02-02	9070-12-12
9070-04-04	9070-16-12
9070-06-06	9070-16-16
9070-08-08	

## 9072

90° MALE NPT X FEMALE BSPP (SWIVEL) ELBOW

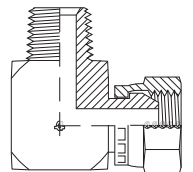

9072-02-02	9072-12-12
9072-04-04	9072-16-16
9072-06-06	9072-20-20
9072-08-08	9072-24-24

## 9075

90° FEMALE BSPP (SWIVEL) ELBOW

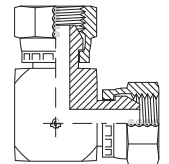

9075-02-02	9075-08-08	9075-16-16
9075-04-04	9075-10-10	9075-20-20
9075-06-04	9075-12-12	9075-24-24
9075-06-06	9075-16-12	9075-32-32

# STEEL INTERNATIONAL ADAPTERS

## 9076

90° FEM. BSP FIXED ELBOW

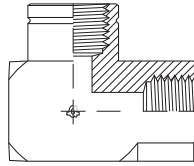

9076-04-04	9076-08-08	9076-16-16
9076-06-06	9076-12-12	9076-24-24

## 9077

90° MALE BSPP X MALE ORB ADJ. ELBOW

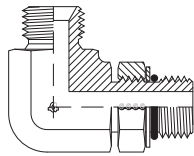

9077-02-04	9077-08-08
9077-04-06	9077-08-10
9077-06-06	9077-12-12
9077-06-08	9077-16-16

## 9078

MALE BSPP X MALE ORB RUN TEE

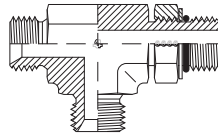

9078-02-02-04	9078-08-08-10	9078-12-12-12
9078-06-06-08	9078-12-12-10	9078-16-16-16

## 9079

MALE BSPP X MALE ORB BRANCH TEE

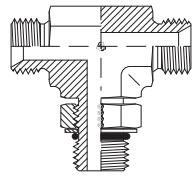

9079-02-02-04	9079-08-08-08	9079-12-12-12
9079-06-06-08	9079-08-08-10	9079-16-16-16

## 9080

MALE BSPP TEE

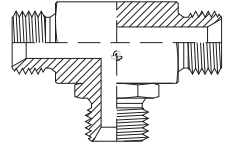

9080-02-02-02	9080-08-08-08	9080-16-16-08
9080-04-04-04	9080-08-08-12*	9080-16-16-16
9080-04-04-06*	9080-10-10-10	9080-20-20-20
9080-06-06-04	9080-12-12-08	9080-24-24-24
9080-06-06-06	9080-12-12-12	9080-32-32-32
9080-06-06-08*	9080-12-12-16*	

## 9085

FEMALE BSPP SWIVEL TEE

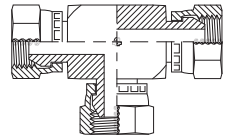

9085-02-02-02	9085-10-10-10	9085-24-24-24
9085-04-04-04	9085-12-12-12	9085-32-32-32
9085-06-06-06	9085-16-16-16	
9085-08-08-08	9085-20-20-20	

## 9086

FEMALE BSP SOLID TEE

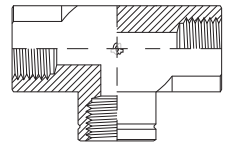

9086-02-02-02	9086-10-10-10*
9086-04-04-04	9086-12-12-12
9086-06-06-06	9086-16-16-16
9086-08-08-08	9086-20-20-20

## 9087

FEMALE BSPP (SWIVEL) BRANCH TEE

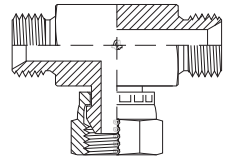

9087-02-02-02	9087-10-10-10	9087-24-24-24
9087-04-04-04	9087-12-12-12	
9087-06-06-06	9087-16-16-16	
9087-08-08-08	9087-20-20-20	

# STEEL INTERNATIONAL ADAPTERS

## 9090

FEMALE BSPP (SWIVEL) RUN TEE

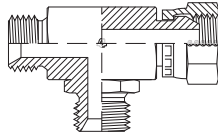

9090-02-02-02	9090-06-08-08*	9090-16-16-16
9090-04-04-04	9090-08-08-08	9090-20-20-20
9090-04-06-06	9090-10-10-10	9090-24-24-24
9090-06-04-06*	9090-12-12-06	
9090-06-06-04	9090-12-12-08	
9090-06-06-06	9090-12-12-12	

\* FORGED BODY

## 9095

MALE BSPP RUN TEE (SWIVEL)

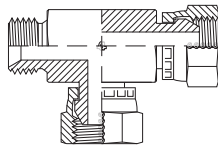

9095-02-02-02	9095-10-10-10
9095-04-04-04	9095-12-12-12
9095-06-06-06	9095-16-16-16
9095-08-08-08	9095-20-20-20

## 9096

MALE BSPP CROSS

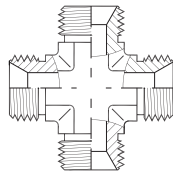

9096-06	9096-12
9096-08	9096-24

## 9097

FEMALE BSP CROSS SOLID

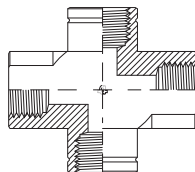

9097-04	9097-16
9097-08	9097-20

## 9120

MALE ORB X FEMALE BSPP

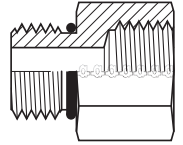

9120-04-04	9120-06-06	9120-12-08
9120-06-04	9120-08-04	

## 9135

90° MALE BSPP ADJ. X FEMALE NPT ELBOW

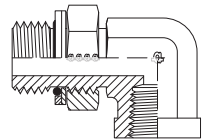

9135-02-02	9135-06-06	9135-16-16
9135-04-02	9135-08-06	9135-20-20
9135-04-04	9135-08-08	9135-24-24
9135-06-04	9135-12-12	

## 9151

MALE BSPP ADJ. RUN TEE

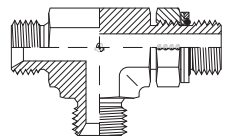

9151-04-04-04	9151-06-06-06	9151-08-08-08
9151-06-06-04	9151-08-08-06	9151-12-12-12

## 9152

MALE BSPP ADJ. BRANCH TEE

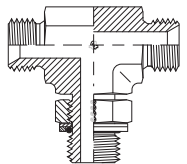

9152-04-04-04	9152-06-06-06	9152-08-08-08
9152-06-06-04	9152-08-08-06	9152-12-12-12

## 9158

MALE BSPP RUN TEE X MALE JIC

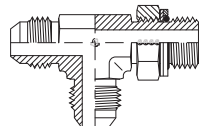

9158-04-04-04	9158-08-08-06	9158-16-16-16
9158-05-05-04	9158-08-08-08	9158-20-20-20
9158-06-06-04	9158-10-10-08	
9158-06-06-06	9158-12-12-12	

# STEEL INTERNATIONAL ADAPTERS

## 9159

MALE BSPP BRANCH TEE X MALE JIC

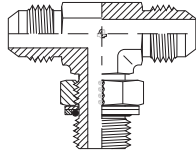

9159-04-04-04	9159-08-08-06	9159-16-16-16
9159-05-05-04	9159-08-08-08	
9159-06-06-04	9159-10-10-08	
9159-06-06-06	9159-12-12-12	

## 9163

MALE BSPT RUN TEE X MALE JIC

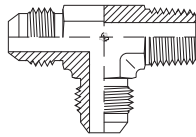

9163-04-04-04	9163-08-08-06	9163-12-12-12
9163-06-06-04	9163-10-10-08	

## 9164

MALE BSPT BRANCH TEE X MALE JIC

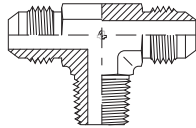

9164-06-06-04	9164-12-12-12
9164-10-10-08	

## 9168

MALE JIC X METRIC RUN TEE

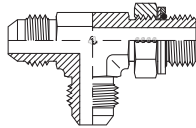

9168-04-04-12	9168-08-08-16	9168-10-10-22
9168-06-06-14	9168-08-08-18	9168-12-12-27

## 9169

MALE JIC X METRIC BRANCH TEE

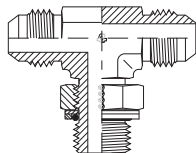

9169-04-04-10	9169-08-08-18
9169-04-04-12	9169-10-10-22
9169-06-06-14	9169-12-12-27
9169-08-08-16	9169-16-16-33

## 9197

MALE JIC X FEMALE METRIC DIN (SWIVEL)

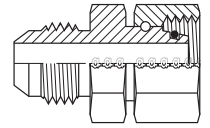

9197-04-L06-12	9197-08-S12-20	9197-16-L28-36
9197-04-L08-14	9197-08-S16-24	9197-16-S25-36
9197-04-S06-14	9197-10-L15-22	9197-20-L35-45
9197-06-L08-14	9197-10-S16-24	9197-20-S30-42
9197-06-L10-16	9197-12-L18-26	9197-24-L42-52
9197-06-S08-16	9197-12-L22-30	9197-24-S38-52
9197-06-S10-18	9197-12-S20-30	
9197-08-L12-18	9197-16-L22-30	

## 9199

90° MALE JIC X FEMALE METRIC DIN (SWIVEL) ELBOW

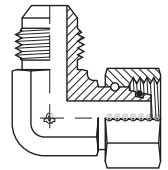

9199-04-L06-12	9199-08-L12-18	9199-16-L22-30
9199-04-S06-14	9199-08-S12-20	9199-16-L28-36
9199-06-L08-14	9199-10-L15-22	9199-16-S25-36
9199-06-L10-16	9199-10-S16-24	9199-20-L35-45
9199-06-S08-16	9199-12-L18-26	9199-20-S30-42
9199-06-S10-18	9199-12-S20-30	9199-24-L42-52

## 9200

MALE JIC X DIN STANDPIPE

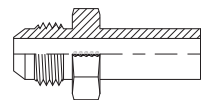

9200-03-04	9200-08-14	9200-16-28
9200-04-04	9200-08-15	9200-16-30
9200-04-06	9200-08-16	9200-20-28
9200-04-08	9200-10-16	9200-20-35
9200-04-10	9200-10-18	9200-20-38
9200-05-12	9200-10-20	9200-24-35
9200-06-08	9200-12-16	9200-24-38
9200-06-10	9200-12-18	9200-24-42
9200-06-12	9200-12-20	9200-32-40
9200-06-14	9200-12-22	
9200-08-10	9200-12-25	
9200-08-12	9200-16-25	

# STEEL INTERNATIONAL ADAPTERS

## 9210

MALE JIC X FEMALE FLAT-FACE  
BSPP (SWIVEL) HIAB

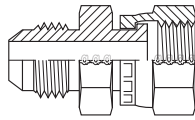

9210-04-04	9210-08-10	9210-12-16
9210-06-04	9210-08-12	9210-16-12
9210-06-06	9210-10-08	9210-16-16
9210-06-08	9210-10-10	
9210-08-06	9210-10-12	
9210-08-08	9210-12-12	

## 9220

MALE JIC X SOLID FEMALE JIS

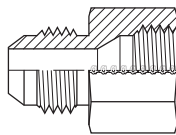

9220-04-02	9220-08-06	9220-16-16
9220-04-04	9220-08-08	9220-20-20
9220-06-04	9220-10-10	9220-24-24
9220-06-06	9220-12-12	9220-32-32

## 9221

JIS HEX PLUG

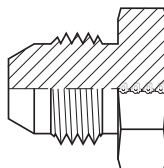

9221-02	9221-10	9221-24
9221-04	9221-12	9221-32
9221-06	9221-16	
9221-08	9221-20	

## 9222

JIS SWIVEL CAP

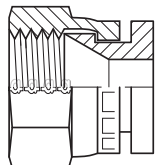

9222-02	9222-10	9222-24
9222-04	9222-12	9222-32
9222-06	9222-16	
9222-08	9222-20	

## 9223

MALE JIS X MALE BSPT

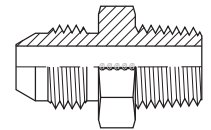

9223-04-04	9223-08-06	9223-16-16
9223-04-06	9223-08-08	9223-20-20
9223-06-04	9223-12-08	9223-24-24
9223-06-06	9223-12-12	9223-32-32

## 9224

90° MALE JIS X MALE BSPT  
ELBOW

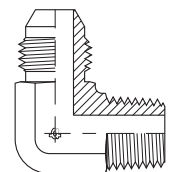

9224-04-02	9224-06-06	9224-12-12
9224-04-04	9224-08-08	9224-16-16

## 9225

45° MALE JIS X MALE BSPT  
ELBOW

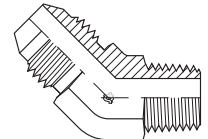

9225-04-04	9225-08-08	9225-16-16
9225-06-06	9225-12-12	

## 9226

FEMALE JIC X FEMALE JIS SWIVEL



9226-06-06
9226-08-08

## 9228

MALE JIC X 50° MALE NISSAN  
(METRIC THREAD)

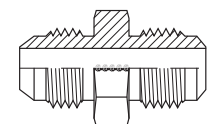

9228-06-16
------------

# STEEL INTERNATIONAL ADAPTERS

## 9229

MALE JIC X 50° FEMALE NISSAN  
(METRIC THREAD)

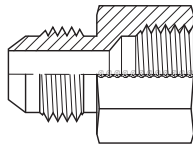

9229-06-16

## 9234

MALE METRIC X FEMALE BSPT

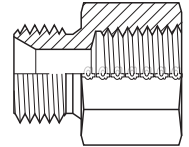

9234-08X1.0-02

## 9230

MALE JIC X FEMALE KOMATSU

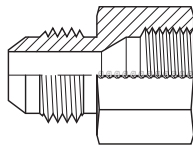

9230-04-12

9230-08-22

9230-04-14

9230-10-24

9230-06-16

9230-12-30

9230-06-18

9230-16-33

## 9235

MALE METRIC X FEMALE NPT

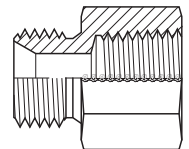

9235-04X.70-02

9235-20-04

9235-06X.75-02

9235-20-06

9235-06X.75-04

9235-20-08

9235-06X1.0-02

9235-22-04

9235-08X1.0-02

9235-22-06

9235-08X1.25-02

9235-22-08

9235-10-02

9235-22-12

9235-10-04

9235-24-12

9235-10-06

9235-26-04

9235-10X1.25-02

9235-26-08

9235-10X1.5-02

9235-26-12

9235-10X1.5-04

9235-27-12

9235-12-02

9235-27X1.5-12

9235-12-04

9235-30-12

9235-12-06

9235-30X1.5-06

9235-12X1.0-02

9235-30X1.5-08

9235-12X1.0-04

9235-30X1.5-12

9235-12X1.25-04

9235-33-16

9235-14-04

9235-33X1.5-08

9235-14-06

9235-36-16

9235-16-04

9235-40-24

9235-16-06

9235-42-16

9235-16-08

9235-42-20

9235-18-04

9235-42X1.5-24

9235-18-06

9235-48-24

9235-18-08

## 9231

KOMATSU PLUG

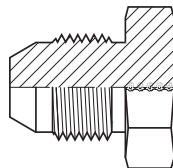

9231-14

9231-24

9231-42

9231-16

9231-30

9231-18

9231-33

9231-22

9231-36

## 9232

KOMATSU CAP

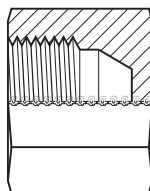

9232-14

9232-24

9232-16

9232-30

9232-18

9232-33

9232-22

9232-42

## 9233

MALE KOMATSU X MALE BSPT

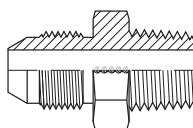

9233-14-02

9233-16-04



# STEEL INTERNATIONAL ADAPTERS

## 9236

MALE KOMATSU UNION

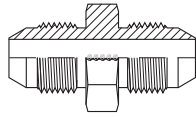

9236-14-14  
9236-18-18

9236-22-22  
9236-24-24

9236-30-30  
9236-33-33

## 9237

MALE JIC X MALE KOMATSU UNION

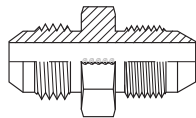

9237-04-14  
9237-06-16  
9237-06-18  
9237-08-22

9237-10-24  
9237-12-30  
9237-16-33

## 9240

MALE JIC X FEMALE BSPP SWIVEL

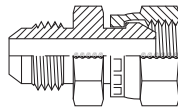

9240-04-02  
9240-04-04  
9240-04-06  
9240-04-08  
9240-05-04  
9240-05-06  
9240-05-08  
9240-06-04  
9240-06-06  
9240-06-08

9240-08-06  
9240-08-08  
9240-08-10  
9240-08-12  
9240-10-06  
9240-10-08  
9240-10-10  
9240-10-12  
9240-12-08  
9240-12-12

9240-12-16  
9240-14-12  
9240-16-12  
9240-16-16  
9240-20-20  
9240-24-24  
9240-32-32

## 9245

MALE JIC X JSW MALE TUBE END

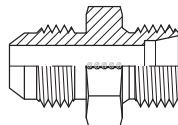

9245-12-25-34  
9245-20-38-48

## 9246

MALE JSW TUBE PLUG

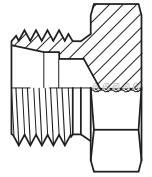

9246-25-34

## 9247

MALE JIC X MALE KOBELCO

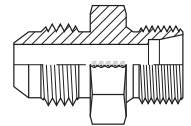

9247-12-22-30  
9247-12-28-36

9247-16-22-30  
9247-16-28-36

9247-16-35-45  
9247-20-35-45

## 9248

KOBELCO TUBE PLUG

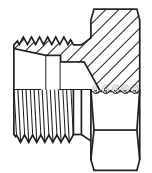

9248-22-30  
9248-28-36

9248-35-45

## 9249

KOBELCO (SWIVEL) CAP

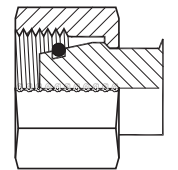

9249-22-30  
9249-28-36

9249-35-45

## 9250

90° MALE JIC X FEMALE BSPP SWIVEL ELBOW

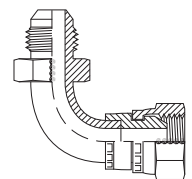

9250-04-04  
9250-06-06

9250-08-08  
9250-10-10

9250-12-12  
9250-16-16

# STEEL INTERNATIONAL ADAPTERS

## 9259

90° MALE JIS X MALE BSPP ADJ. ELBOW

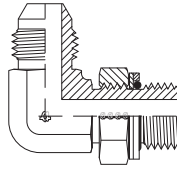

9259-06-06  
9259-08-08

## 9292

90° MALE X FEMALE JIS ELBOW

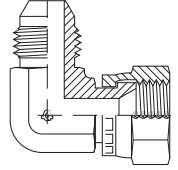

9292-04-04      9292-08-08  
9292-06-06      9292-12-12

## 9260

45° MALE JIC X FEMALE BSPP SWIVEL ELBOW

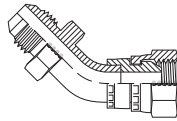

9260-04-04      9260-08-08      9260-16-16  
9260-06-06      9260-12-12

## 9293TP

JIS TEST PORT TEE (SWIVEL)

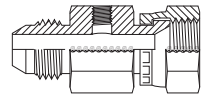

9293TP-04-04      9293TP-08-08  
9293TP-06-06

## 9277

MALE JIS X MALE SAE ORB

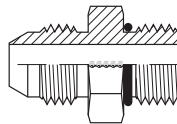

9277-04-06      9277-06-04      9277-08-06  
9277-04-08      9277-06-06

## 9294

45° MALE JIS X FEMALE JIS SWIVEL ELBOW

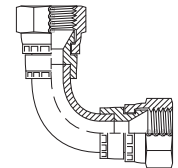

9294-04-04      9294-08-08  
9294-06-06

## 9278

90° MALE JIS X MALE SAE ORB ELBOW

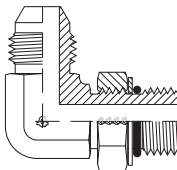

9278-04-04  
9278-08-06

## 9325

MALE NPT X FEMALE METRIC FIXED

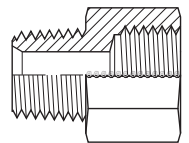

9325-02-06X1.0	9325-04-16X1.5	9325-12-20X1.5
9325-02-08X1.0	9325-06-14X1.5	9325-12-26X1.5
9325-02-10X1.0	9325-06-16X1.5	9325-12-30X1.5
9325-02-10X1.25	9325-06-18X1.5	9325-12-30X2.0
9325-02-10X1.5	9325-08-14X1.5	9325-16-26X1.5
9325-02-12X1.0	9325-08-18X1.5	9325-20-30X1.5
9325-02-12X1.5	9325-08-20X1.5	
9325-04-10X1.0	9325-08-22X1.5	
9325-04-12X1.5	9325-08-24X1.5	
9325-04-14X1.5	9325-12-18X1.5	

## 9291

FEMALE JIS RUN TEE

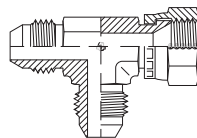

9291-04-04-04      9291-08-08-08  
9291-06-06-06      9291-12-12-12

# STEEL INTERNATIONAL ADAPTERS

## 9327

FEMALE KOMATSU SWIVEL UNION

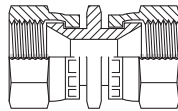

9327-14-14  
9327-18-18

9327-22-22  
9327-24-24

9327-30-30

## 9337

MALE JIC X MALE JIS

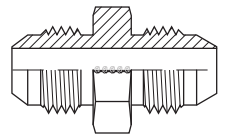

9337-04-02  
9337-04-04

9337-06-06  
9337-08-08

9337-12-12  
9337-16-16

## 9333

30° TO 37° CONVERSION SEAT

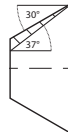

9333-12MM  
9333-14MM  
9333-16MM  
9333-18MM

9333-22MM  
9333-24MM  
9333-30MM

## 9355

90° FEMALE JIC X FEMALE JIC SWIVEL ELBOW

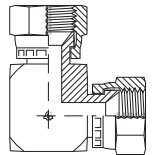

9355-04-04  
9355-05-05  
9355-06-06  
9355-08-08

9355-10-10  
9355-12-12  
9355-16-16

## 9335

MALE METRIC X FEMALE SAE ORB

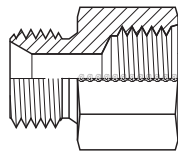

9335-08X1.0-04  
9335-12X1.0-04  
9335-14-06  
9335-16-06

9335-18-08  
9335-22-06  
9335-22-10  
9335-26-12

9335-27-12  
9335-33-16  
9325-04-16X1.5

## 9391

FEMALE KOMATSU RUN TEE

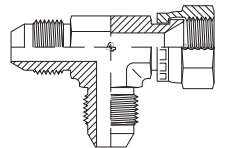

9391-14-14-14  
9391-16-16-16  
9391-18-18-18  
9391-22-22-22

9391-24-24-24  
9391-30-30-30  
9391-33-33-33

## 9336

MALE JIS UNION

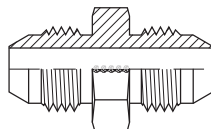

9336-02-02  
9336-04-04  
9336-06-06  
9336-08-08

9336-12-12  
9336-16-16  
9336-20-20

## 9392

90° MALE KOMATSU X FEMALE KOMATSU ELBOW

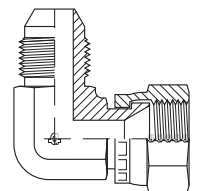

9392-14-14  
9392-16-16  
9392-18-18  
9392-22-22

9392-24-24  
9392-30-30  
9392-33-33

# STEEL INTERNATIONAL ADAPTERS

## 9474

BSPP ADJUSTABLE NIPPLE C/W OR & RR

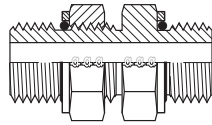

9474-02-02	9474-12-12
9474-04-04	9474-16-16
9474-06-06	9474-20-20
9474-08-08	9474-24-24

## 9555

FEMALE JIC (SWIVEL) TEE

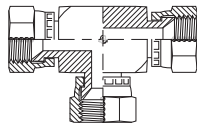

9555-04-04-04	9555-10-10-10
9555-05-05-05	9555-12-12-12
9555-06-06-06	9555-16-16-16
9555-08-08-08	9555-20-20-20

## 9605

MALE JIC X MALE METRIC DIN (EXTRA LIGHT AND LIGHT)

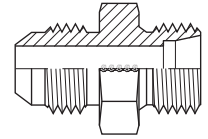

9605-04-06X1.0*	9605-08-L12-18
9605-04-08X1.0*	9605-08-L15-22
9605-04-08X1.25*	9605-10-25X1.5*
9605-04-10X1.25*	9605-10-L12-18
9605-04-10X1.5*	9605-10-L15-22
9605-04-12X1.0*	9605-10-L18-26
9605-04-L06-12	9605-12-25X1.5*
9605-04-L08-14	9605-12-30X1.5*
9605-04-L10-16	9605-12-L15-22
9605-04-LL06-10	9605-12-L18-24X1.5
9605-04-LL08-12	9605-12-L18-26
9605-05-12X1.0*	9605-12-L22-30
9605-05-12X1.25*	9605-12-L22-30X1.5
9605-06-10X1.5*	9605-16-L18-26
9605-06-12X1.25*	9605-16-L22-30X1.5
9605-06-12X1.75	9605-16-L28-36
9605-06-L08-14	9605-20-33X2.0*
9605-06-L10-16	9605-20-50X1.5*
9605-06-L12-18	9605-20-L27-38X1.5
9605-06-L15-22	9605-20-L35-45
9605-06-LL06-10	9605-24-L42-52
9605-06-LL08-12	
9605-08-12X1.25*	
9605-08-L10-16	

## 9605S

MALE JIC X MALE METRIC DIN (LIGHT DUTY) COMES W/ WASHER & O-RING

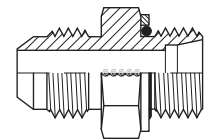

9605S-04-L06-12	9605S-08-L15-22
9605S-04-L08-14	9605S-10-L15-22
9605S-04-LL06-10	9605S-10-L18-26
9605S-04-LL08-12	9605S-12-L15-22
9605S-06-L08-14	9605S-12-L18-26
9605S-06-L10-16	9605S-12-L22-30
9605S-06-L12-18	9605S-16-L28-36
9605S-06-LL08-12	9605S-20-L35-45
9605S-08-L10-16	9605S-24-L42-52
9605S-08-L12-18	

\* PORT ONLY

# STEEL INTERNATIONAL ADAPTERS

## 9606

MALE JIC X MALE METRIC DIN  
(HEAVY DUTY)

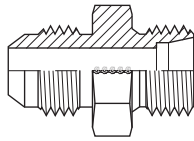

9606-04-S06-14	9606-10-S14-22
9606-04-S08-16	9606-10-S16-24
9606-04-S10-18	9606-12-S16-24
9606-06-S08-16	9606-12-S20-30
9606-06-S10-18	9606-12-S25-36
9606-06-S12-20	9606-16-S20-30
9606-06-S14-22	9606-16-S25-36
9606-08-S10-18	9606-16-S30-42
9606-08-S12-20	9606-20-S30-42
9606-08-S14-22	9606-20-S38-52
9606-08-S16-24	9606-24-S38-52
9606-10-S12-20	

## 9606S

MALE JIC X MALE METRIC  
DIN (HEAVY DUTY) COMES W/  
WASHER & O-RING

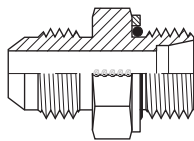

9606S-04-S06-14	9606S-12-S16-24
9606S-04-S08-16	9606S-12-S20-30
9606S-06-S08-16	9606S-12-S25-36
9606S-06-S10-18	9606S-16-S20-30
9606S-06-S12-20	9606S-16-S25-36
9606S-06-S14-22	9606S-16-S30-42
9606S-08-S10-18	9606S-20-S30-42
9606S-08-S12-20	9606S-20-S38-52
9606S-08-S16-24	9606S-24-S38-52
9606S-10-S12-20	
9606S-10-S14-22	
9606S-10-S16-24	

## 9607

MALE NPT X MALE DIN METRIC

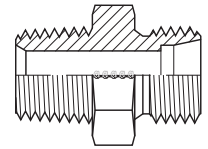

9607-02-12	9607-08-16
9607-02-LL06-10	9607-08-L12-18
9607-04-08X1.25	9607-08-L15-22
9607-04-10X1.0	9607-08-S12-20
9607-04-12X1.25	9607-16-30
9607-04-14	9607-24-38X1.5
9607-06-12X1.25	9607-24-S30-42
9607-06-18	
9607-06-L12-18	
9607-08-12X1.25	

## 9622

MALE JIC X FEMALE METRIC  
FIXED

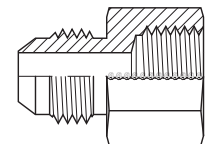

9622-04-06X1.0	9622-04-10X1.0
9622-04-08X1.0	

## 9624

FEMALE JIC X MALE METRIC DIN

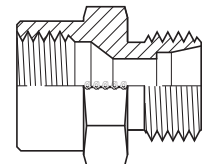

9624-04-L06-12	9624-08-S12-20	9624-20-S30-42
9624-04-S06-14	9624-08-S14-22	9624-24-L35-45
9624-06-L08-14	9624-08-S16-24	9624-24-L42-52
9624-06-L10-16	9624-12-L18-26	9624-24-S38-52
9624-06-S08-16	9624-12-L22-30	
9624-06-S10-18	9624-12-S20-30	
9624-08-L12-18	9624-16-L28-36	
9624-08-L15-22	9624-16-S25-36	

## 9634TP

KOMATSU TEST PORT TEE  
(TP=NPT)

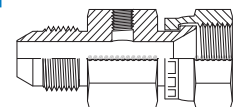

9634TP-14-14-02	9634TP-22-22-06	9634TP-30-30-06
9634TP-18-18-04	9634TP-24-24-06	9634TP-33-33-08

# STEEL INTERNATIONAL ADAPTERS

## 9635S

MALE METRIC DIN (LIGHT DUTY)  
COMES W/ WASHER & O-RING X  
FEMALE NPT

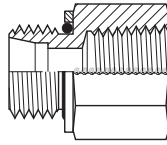

9635S-12-L06-04	9635S-18-L12-06
9635S-12-L06-06	9635S-18-L12-08
9635S-14-L08-04	9635S-22-L15-06
9635S-14-L08-06	9635S-22-L15-08
9635S-16-L10-04	9635S-22-L15-12
9635S-16-L10-06	9635S-26-L18-12
9635S-16-L10-08	9635S-30-L22-12
9635S-18-L12-04	9635S-30X1.5-L22-12

## 9636S

MALE METRIC DIN (HEAVY DUTY)  
COMES W/ WASHER & O-RING X  
FEMALE NPT

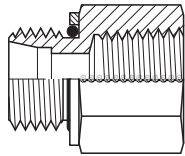

9636S-14-S06-06	9636S-42-S30-20
9636S-20-S12-04	
9636S-24-S16-12	
9636S-42-S30-16	

## 9638

METRIC PORT BUSHING

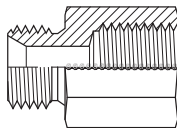

9638-08X1.0-06X1.0	9638-22X1.5-14X1.5
9638-10X1.0-08X1.0	9638-22X1.5-18X1.5
9638-14X1.5-10X1.0	9638-24X1.5-20X1.5
9638-16X1.5-12X1.5	9638-26X1.5-22X1.5
9638-16X1.5-22X1.5	9638-27X2.0-18X1.5
9638-18X1.5-10X1.0	9638-30X2.0-26X1.5
9638-18X1.5-14X1.5	9638-33X2.0-14X1.5
9638-18X1.5-16X1.5	9638-36X2.0-30X2.0
9638-18X1.5-27X2.0	9638-42X2.0-14X1.5
9638-20X1.5-16X1.5	9638-48X2.0-42X2.0

## 9643

FEMALE NPT X FEMALE METRIC  
FIXED

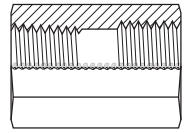

9643-02-06X1.0	9643-04-14X1.5
9643-02-08X1.0	9643-04-16X1.5
9643-02-10X1.0	
9643-04-12X1.5	

## 9777

BSPP FLAT FACE CONVERSION  
ADAPTER HIAB

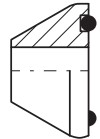

9777-06	9777-12
9777-08	

## 9900

FEMALE BSPP (SWIVEL) X HOSE  
BARB

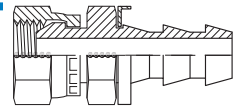

9900-04-04	9900-08-08	9900-12-12
9900-06-06	9900-10-10	9900-16-16

## 9905

45° FEMALE BSPP (SWIVEL) X  
HOSE BARB ELBOW

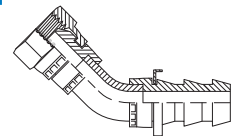

9905-04-04	9905-08-08	9905-12-12
9905-06-06	9905-10-10	9905-16-16

## 9910

90° FEMALE BSPP (SWIVEL) X  
HOSE BARB ELBOW

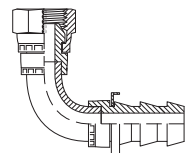

9910-04-04	9910-08-08	9910-12-12
9910-06-06	9910-10-10	9910-16-16

# STEEL INTERNATIONAL ADAPTERS

## 9915

MALE BSPT X PUSH ON HOSE BARB

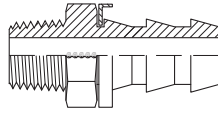

9915-04-04	9915-08-08
9915-06-06	9915-12-12
9915-06-08	9915-16-16
9915-08-06	9915-20-20

## 9920

MALE BSPP X HOSE BARB

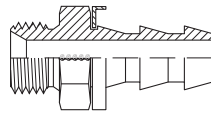

9920-04-04	9920-08-08	9920-16-16
9920-06-06	9920-12-12	

## 9921

MALE BSPP X HOSE BARB (NEEDS CLAMP)

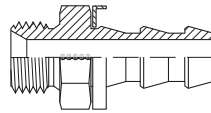

9921-04-06	9921-12-10	9921-24-28
9921-06-08	9921-12-16	9921-24-32
9921-08-06	9921-16-16	9921-32-32
9921-08-08	9921-16-20	
9921-08-10	9921-20-24	
9921-12-08	9921-24-24	

## 9500

BONDED SEAL FOR BSPP THREAD

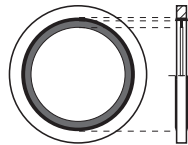

9500-02	9500-10	9500-24
9500-04	9500-12	9500-32
9500-06	9500-16	9500-40
9500-08	9500-20	9500-48

## 9500MM

BONDED SEAL FOR METRIC THREAD

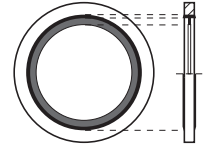

9500-04MM	9500-20MM	9500-42MM
9500-06MM	9500-22MM	9500-45MM
9500-08MM	9500-24MM	9500-50MM
9500-10MM	9500-26MM	9500-52MM
9500-12MM	9500-27MM	
9500-14MM	9500-30MM	
9500-16MM	9500-33MM	
9500-18MM	9500-36MM	

## 9500NSC

BONDED SEAL FOR BSPP THREAD NON-SELF CENTERING

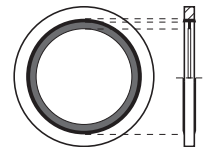

9500-002NSC	9500-008NSC
9500-004NSC	9500-010NSC
9500-006NSC	9500-020NSC

## 9500MM-NSC

BONDED SEAL FOR BSPP THREAD NON-SELF CENTERING

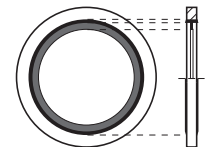

9500-010MMNSC	9500-018MMNSC
9500-012MMNSC	9500-020MMNSC
9500-014MMNSC	9500-022MMNSC

## 9500V

BONDED VITON SEAL FOR BSPP THREAD

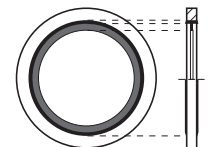

9500-02V	9500-10V	9500-24V
9500-04V	9500-12V	9500-32V
9500-06V	9500-16V	9500-40V
9500-08V	9500-20V	9500-48V

# STEEL INTERNATIONAL ADAPTERS

## 9500MM-V

BONDED VITON SEAL FOR METRIC THREAD

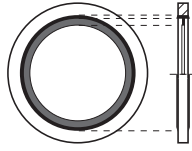

9500-10MMV	9500-18MMV	9500-26MMV
9500-12MMV	9500-20MMV	
9500-14MMV	9500-22MMV	
9500-16MMV	9500-24MMV	

## 9536

MALE BSPT X FEMALE SAE ORB

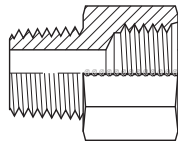

9536-02-04	9536-08-10
9536-04-06	9536-12-12
9536-06-08	9536-16-16
9536-08-08	

## 9999

BSPP TO JIS CONVERSION SEAT

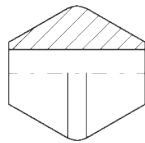

9999-02	9999-10	9999-24
9999-04	9999-12	
9999-06	9999-16	
9999-08	9999-20	

## CWM

COPPER WASHER METRIC

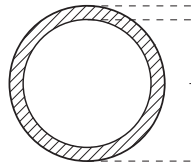

CWM-08	CWM-16	CWM-30
CWM-10	CWM-18	
CWM-12	CWM-20	
CWM-14	CWM-22	

## CWR

COPPER WASHER BSPP

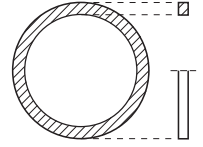

CWR-1/8"	CWR-5/8"	CWR-1-1/2"
CWR-1/4"	CWR-3/4"	
CWR-3/8"	CWR-1"	
CWR-1/2"	CWR-1-1/4"	

## ESB

BSPP ELASTOMERIC SEAL

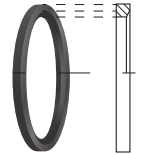

ESB-02	ESB-10	ESB-24
ESB-04	ESB-12	ESB-32
ESB-06	ESB-16	
ESB-08	ESB-20	

## ESM

METRIC ELASTOMERIC SEAL



ESM-10	ESM-20
ESM-12	ESM-22
ESM-16	
ESM-18	

## OR

O-RING FOR BSPP THREAD



OR-02	OR-12
OR-04	OR-16
OR-06	OR-20
OR-08	OR-24



# STEEL INTERNATIONAL ADAPTERS

## OR-MM

O-RING FOR METRIC THREAD



OR-10MM	OR-18MM	OR-27MM
OR-12MM	OR-20MM	OR-30MM
OR-14MM	OR-22MM	OR-33MM
OR-16MM	OR-26MM	OR-42MM

## RR

RETAINING RING BSPP

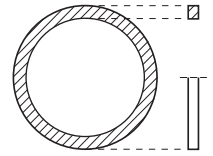

RR-02	RR-12
RR-04	RR-16
RR-06	RR-20
RR-08	RR-24

## ORFS

O-RING FOR O-RING FACE SEAL



ORFS-04	ORFS-12
ORFS-06	ORFS-16
ORFS-08	ORFS-20
ORFS-10	ORFS-24

## RR-MM

RETAINING RING METRIC

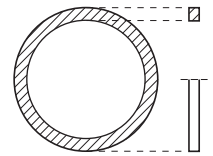

RR-10MM	RR-22MM	RR-42MM
RR-12MM	RR-24MM	RR-48MM
RR-14MM	RR-26MM	
RR-16MM	RR-27MM	
RR-18MM	RR-30MM	
RR-20MM	RR-33MM	

## SAE BOSS O-RING

O-RING FOR SAE BOSS THREAD



3-904	3-910	3-924
3-905	3-912	3-932
3-906	3-916	
3-908	3-920	

## 8400

ALUMINUM WASHER BSPP  
THREAD

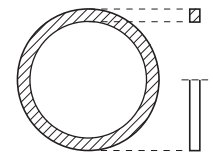

8400-04	8400-08
8400-06	8400-12

## O-RING MISC

MISC O-RINGS



6-035	6-1039	6-850
6-038	6-087	6-869
6-091	6-275	6-472
6-010	6-619	6-1197
6-003	6-139	6-433
6-928	6-745	6-575
6-065	6-656	
6-006	6-1540	

# STAINLESS STEEL DIN TUBE FITTINGS

## SS5000L

STAINLESS DIN UNION LIGHT DUTY

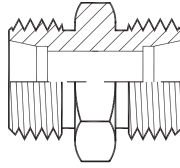

SS5000L-06	SS5000L-15
SS5000L-08	SS5000L-18
SS5000L-10	SS5000L-22
SS5000L-12	SS5000L-28

## SS5002L

STAINLESS DIN LIGHT DUTY X MALE BSPP ES SEAL

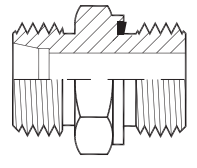

SS5002L-06-02	SS5002L-10-08	SS5002L-18-08
SS5002L-06-04	SS5002L-12-04	SS5002L-18-12
SS5002L-08-02	SS5002L-12-06	SS5002L-22-12
SS5002L-08-04	SS5002L-12-08	SS5002L-28-16
SS5002L-10-04	SS5002L-15-06	SS5002L-35-20
SS5002L-10-06	SS5002L-15-08	

## SS5000S

STAINLESS DIN UNION HEAVY DUTY

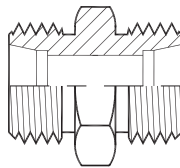

SS5000S-06	SS5000S-14
SS5000S-08	SS5000S-16
SS5000S-10	SS5000S-20
SS5000S-12	SS5000S-25

## SS5002S

STAINLESS DIN HEAVY DUTY X MALE BSPP ES SEAL

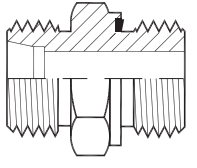

SS5002S-06-04	SS5002S-12-04	SS5002S-16-12
SS5002S-08-04	SS5002S-12-06	SS5002S-20-08
SS5002S-08-06	SS5002S-12-08	SS5002S-20-12
SS5002S-10-04	SS5002S-14-08	SS5002S-25-12
SS5002S-10-06	SS5002S-16-06	SS5002S-25-16
SS5002S-10-08	SS5002S-16-08	SS5002S-30-20

## SS5001L

STAINLESS DIN LIGHT DUTY X MALE BSPP SHOULDER SEAL (FORM B)

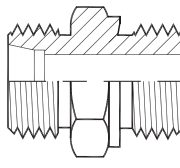

SS5001L-06-02	SS5001L-10-08	SS5001L-18-08
SS5001L-06-04	SS5001L-12-04	SS5001L-18-12
SS5001L-08-02	SS5001L-12-06	SS5001L-22-12
SS5001L-08-04	SS5001L-12-08	SS5001L-28-16
SS5001L-10-04	SS5001L-15-06	
SS5001L-10-06	SS5001L-15-08	

## SS5007L

STAINLESS DIN LIGHT DUTY X MALE NPT

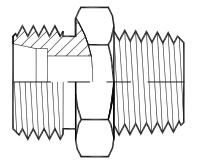

SS5007L-06-02	SS5007L-10-06	SS5007L-15-08
SS5007L-06-04	SS5007L-12-04	SS5007L-18-08
SS5007L-08-04	SS5007L-12-06	SS5007L-22-12
SS5007L-10-04	SS5007L-12-08	SS5007L-28-16

## SS5001S

STAINLESS DIN HEAVY DUTY X MALE BSPP SHOULDER SEAL (FORM B)

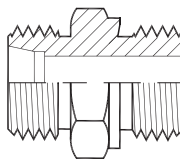

SS5001S-06-04	SS5001S-12-04	SS5001S-16-12
SS5001S-08-04	SS5001S-12-06	SS5001S-20-08
SS5001S-08-06	SS5001S-12-08	SS5001S-20-12
SS5001S-10-04	SS5001S-14-08	SS5001S-25-12
SS5001S-10-06	SS5001S-16-06	SS5001S-25-16
SS5001S-10-08	SS5001S-16-08	

## SS5007S

STAINLESS DIN HEAVY DUTY X MALE NPT

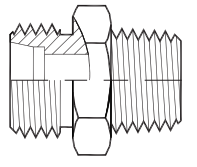

SS5007S-06-04	SS5007S-12-04	SS5007S-16-08
SS5007S-08-04	SS5007S-12-06	SS5007S-20-12
SS5007S-10-04	SS5007S-12-08	SS5007S-25-16
SS5007S-10-06	SS5007S-14-08	SS5007S-30-20

# STAINLESS STEEL DIN TUBE FITTINGS

## SS5040L

STAINLESS DIN BULKHEAD UNION  
LIGHT DUTY

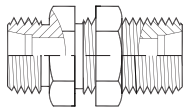

SS5040L-06	SS5040L-15
SS5040L-08	SS5040L-18
SS5040L-10	SS5040L-22
SS5040L-12	SS5040L-28

## SS5040S

STAINLESS DIN BULKHEAD UNION  
HEAVY DUTY

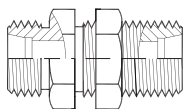

SS5040S-06	SS5040S-14
SS5040S-08	SS5040S-16
SS5040S-10	SS5040S-20
SS5040S-12	SS5040S-25

## SS5042L

STAINLESS 90° DIN LIGHT DUTY  
BULKHEAD UNION

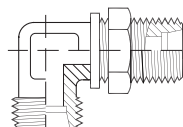

SS5042L-06	SS5042L-15
SS5042L-08	SS5042L-18
SS5042L-10	SS5042L-22
SS5042L-12	SS5042L-28

## SS5042S

STAINLESS 90° DIN HEAVY DUTY  
BULKHEAD UNION

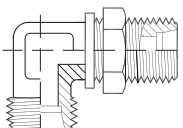

SS5042S-06	SS5042S-14
SS5042S-08	SS5042S-16
SS5042S-10	SS5042S-20
SS5042S-12	SS5042S-25

## SS5055L

STAINLESS 90° DIN UNION LIGHT  
DUTY

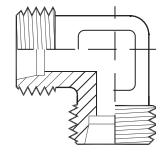

SS5055L-06	SS5055L-15
SS5055L-08	SS5055L-18
SS5055L-10	SS5055L-22
SS5055L-12	SS5055L-28

## 5055S

STAINLESS 90° DIN UNION HEAVY  
DUTY

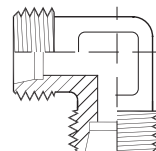

SS5055S-06	SS5055S-14
SS5055S-08	SS5055S-16
SS5055S-10	SS5055S-20
SS5055S-12	SS5055S-25

## SS5059L

STAINLESS 90° DIN LIGHT DUTY X  
MALE BSPP ADJUSTABLE ELBOW

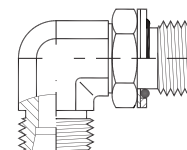

SS5059L-06-02	SS5059L-15-08
SS5059L-08-04	SS5059L-18-08
SS5059L-10-04	SS5059L-22-12
SS5059L-12-06	SS5059L-28-16

## SS5059S

STAINLESS 90° DIN HEAVY DUTY X  
MALE BSPP ADJUSTABLE ELBOW

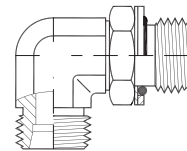

SS5059S-06-04	SS5059S-16-08
SS5059S-08-04	SS5059S-20-12
SS5059S-10-06	SS5059S-25-16
SS5059S-12-06	

# STAINLESS STEEL DIN TUBE FITTINGS

## SS5068L

STAINLESS DIN LIGHT DUTY X  
MALE METRIC ES SEAL

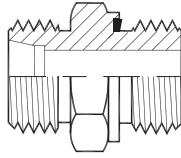

SS5068L-06-10	SS5068L-12-18	SS5068L-22-26
SS5068L-08-12	SS5068L-12-22	SS5068L-28-33
SS5068L-10-14	SS5068L-15-18	
SS5068L-10-18	SS5068L-15-22	
SS5068L-10-22	SS5068L-18-18	
SS5068L-12-16	SS5068L-18-22	

## SS5068S

STAINLESS DIN HEAVY DUTY X  
MALE METRIC ES SEAL

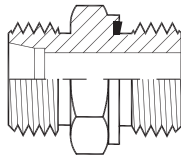

SS5068S-06-12	SS5068S-14-20
SS5068S-08-14	SS5068S-16-22
SS5068S-10-16	SS5068S-20-27
SS5068S-12-18	SS5068S-25-33

## SS5080L

STAINLESS DIN UNION TEE LIGHT  
DUTY

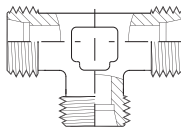

SS5080L-06	SS5080L-15
SS5080L-08	SS5080L-18
SS5080L-10	SS5080L-22
SS5080L-12	SS5080L-28

## SS5080S

STAINLESS DIN UNION TEE HEAVY  
DUTY

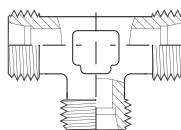

SS5080S-06	SS5080S-14	SS5080S-30
SS5080S-08	SS5080S-16	
SS5080S-10	SS5080S-20	
SS5080S-12	SS5080S-25	

## SS5201L

STAINLESS DIN LIGHT DUTY TUBE  
NUT

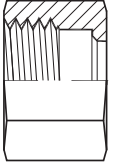

SS5201L-06	SS5201L-15	SS5201L-35
SS5201L-08	SS5201L-18	SS5201L-42
SS5201L-10	SS5201L-22	
SS5201L-12	SS5201L-28	

## SS5201S

STAINLESS DIN HEAVY DUTY TUBE  
NUT

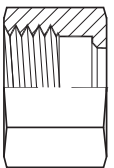

SS5201S-06	SS5201S-14	SS5201S-30
SS5201S-08	SS5201S-16	SS5201S-38
SS5201S-10	SS5201S-20	
SS5201S-12	SS5201S-25	

## SS5202

STAINLESS DIN 2353 CUTTING  
RING

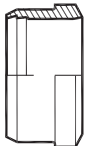

SS5202-06	SS5202-16	SS5202-30
SS5202-08	SS5202-18	SS5202-35
SS5202-10	SS5202-20	SS5202-38
SS5202-12	SS5202-22	SS5202-42
SS5202-14	SS5202-25	
SS5202-15	SS5202-28	

## SS5203L

STAINLESS DIN LIGHT DUTY TUBE  
PLUG

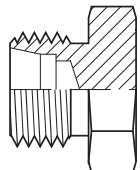

SS5203L-06	SS5203L-15	SS5203L-35
SS5203L-08	SS5203L-18	SS5203L-42
SS5203L-10	SS5203L-22	
SS5203L-12	SS5203L-28	

# STAINLESS STEEL DIN TUBE FITTINGS

## SS5203S

STAINLESS DIN HEAVY DUTY TUBE PLUG

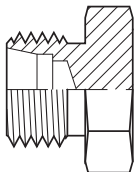

SS5203S-06  
SS5203S-08  
SS5203S-10  
SS5203S-12

SS5203S-14  
SS5203S-16  
SS5203S-20  
SS5203S-25

## SS5300L

STAINLESS FEMALE DIN LIGHT SOFT SEAL UNION

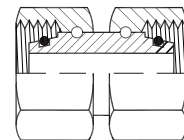

SS5300L-06  
SS5300L-08  
SS5300L-10  
SS5300L-12

SS5300L-15  
SS5300L-18  
SS5300L-22  
SS5300L-28

## SS5204L

STAINLESS DIN LIGHT DUTY TUBE CAP

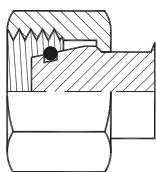

SS5204L-06  
SS5204L-08  
SS5204L-10  
SS5204L-12

SS5204L-15  
SS5204L-18  
SS5204L-22  
SS5204L-28

SS5204L-35

## SS5300S

STAINLESS FEMALE DIN HEAVY SOFT SEAL UNION

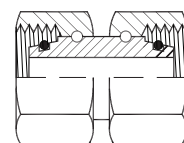

SS5300S-06  
SS5300S-08  
SS5300S-10  
SS5300S-12

SS5300S-14  
SS5300S-16  
SS5300S-20  
SS5300S-25

## SS5204S

STAINLESS DIN HEAVY DUTY TUBE CAP

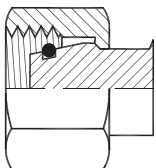

SS5204S-06  
SS5204S-08  
SS5204S-10  
SS5204S-12

SS5204S-14  
SS5204S-16  
SS5204S-20  
SS5204S-25

SS5204S-30  
SS5204S-38

## SS5315L

STAINLESS FEMALE DIN X MALE DIN REDUCER LIGHT DUTY

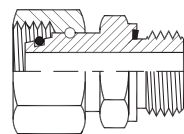

SS5315L-10-06  
SS5315L-10-08  
SS5315L-12-06  
SS5315L-12-08  
SS5315L-12-10  
SS5315L-15-10

SS5315L-15-12  
SS5315L-18-10  
SS5315L-18-12  
SS5315L-18-15  
SS5315L-22-12  
SS5315L-22-15

SS5315L-22-18  
SS5315L-28-18  
SS5315L-28-22

## SS5204P

STAINLESS DIN BLANKING PLUG



SS5204P-06  
SS5204P-08  
SS5204P-10  
SS5204P-12  
SS5204P-14  
SS5204P-15

SS5204P-16  
SS5204P-18  
SS5204P-20  
SS5204P-22  
SS5204P-25  
SS5204P-28

SS5204P-30  
SS5204P-35  
SS5204P-38

## SS5315S

STAINLESS FEMALE DIN X MALE DIN REDUCER HEAVY DUTY

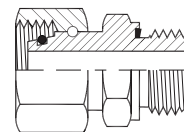

SS5315S-08-06  
SS5315S-10-06  
SS5315S-10-08  
SS5315S-12-08  
SS5315S-12-10  
SS5315S-14-10

SS5315S-14-12  
SS5315S-16-10  
SS5315S-16-12  
SS5315S-16-14  
SS5315S-20-12  
SS5315S-20-16

SS5315S-25-20

# STAINLESS STEEL DIN TUBE FITTINGS

## SS5360L

STAINLESS 90° DIN LIGHT DUTY X FEMALE DIN SWIVEL

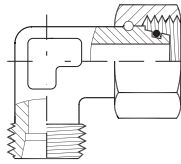

SS5360L-06	SS5360L-15
SS5360L-08	SS5360L-18
SS5360L-10	SS5360L-22
SS5360L-12	SS5360L-28

## SS5390L

STAINLESS DIN X FEMALE DIN LIGHT DUTY SWIVEL RUN TEE

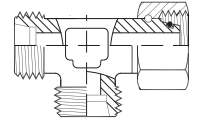

SS5390L-06	SS5390L-15
SS5390L-08	SS5390L-18
SS5390L-10	SS5390L-22
SS5390L-12	SS5390L-28

## SS5360S

STAINLESS 90° DIN HEAVY DUTY X FEMALE DIN SWIVEL

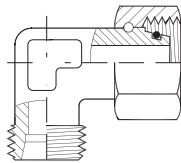

SS5360S-06	SS5360S-14
SS5360S-08	SS5360S-16
SS5360S-10	SS5360S-20
SS5360S-12	SS5360S-25

## SS5390S

STAINLESS DIN X FEMALE DIN HEAVY DUTY SWIVEL RUN TEE

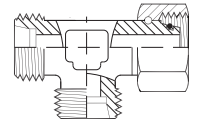

SS5390S-06	SS5390S-14	5390S-30
SS5390S-08	SS5390S-16	5390S-38
SS5390S-10	SS5390S-20	
SS5390S-12	SS5390S-25	

## SS5387L

STAINLESS DIN X FEMALE DIN LIGHT DUTY SWIVEL BRANCH TEE

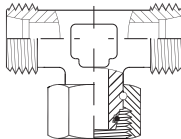

SS5387L-06	SS5387L-15
SS5387L-08	SS5387L-18
SS5387L-10	SS5387L-22
SS5387L-12	SS5387L-28

## 5387S

STAINLESS DIN X FEMALE DIN HEAVY DUTY SWIVEL BRANCH TEE

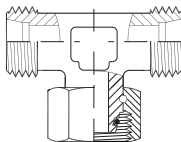

SS5387S-06	SS5387S-14
SS5387S-08	SS5387S-16
SS5387S-10	SS5387S-20
SS5387S-12	SS5387S-25

# STAINLESS STEEL INTERNATIONAL ADAPTERS

## SS9000

STAINLESS MALE BSPP NIPPLE

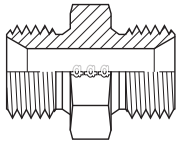

SS9000-02-02	SS9000-08-08	SS9000-20-20
SS9000-04-02	SS9000-10-08	SS9000-24-20
SS9000-04-04	SS9000-12-08	SS9000-24-24
SS9000-06-02	SS9000-12-10	SS9000-32-24
SS9000-06-04	SS9000-12-12	SS9000-32-32
SS9000-06-06	SS9000-16-12	SS9000-48-48
SS9000-08-04	SS9000-16-16	
SS9000-08-06	SS9000-20-16	

## SS9005

STAINLESS MALE JIC X MALE BSPP

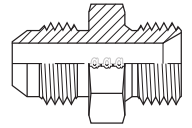

SS9005-04-02	SS9005-08-08	SS9005-16-16
SS9005-04-04	SS9005-08-12	SS9005-20-20
SS9005-06-04	SS9005-10-10	SS9005-20-24
SS9005-06-06	SS9005-12-08	SS9005-24-24
SS9005-06-08	SS9005-12-12	SS9005-32-32
SS9005-08-06	SS9005-16-12	

## SS9002

STAINLESS MALE JIC X MALE BSPP C/W OR & RR

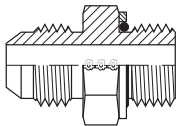

SS9002-04-02	SS9002-08-06	SS9002-16-16
SS9002-04-04	SS9002-08-08	SS9002-16-20
SS9002-04-06	SS9002-08-12	SS9002-20-20
SS9002-06-02	SS9002-10-10	SS9002-20-16
SS9002-06-04	SS9002-12-08	SS9002-24-20
SS9002-06-06	SS9002-12-12	SS9002-24-24
SS9002-06-08	SS9002-12-16	SS9002-32-32
SS9002-08-04	SS9002-16-12	

## SS9006

STAINLESS MALE SAE ORB X MALE BSPP

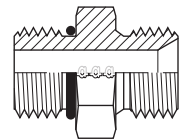

SS9006-04-04	SS9006-08-08	SS9006-20-20
SS9006-04-06	SS9006-08-12	
SS9006-06-04	SS9006-10-08	
SS9006-06-06	SS9006-12-08	
SS9006-06-08	SS9006-12-12	
SS9006-08-06	SS9006-16-16	

## SS9003

STAINLESS BSPP MALE X BSPT MALE

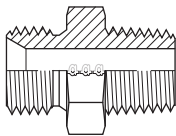

SS9003-02-02	SS9003-08-06	SS9003-16-20
SS9003-02-04	SS9003-08-08	SS9003-20-16
SS9003-04-02	SS9003-08-12	SS9003-20-20
SS9003-04-04	SS9003-10-08	SS9003-24-24
SS9003-04-06	SS9003-12-12	SS9003-32-32
SS9003-06-04	SS9003-12-16	
SS9003-06-06	SS9003-16-12	
SS9003-06-08	SS9003-16-16	

## SS9007

STAINLESS MALE BSPP X MALE NPT

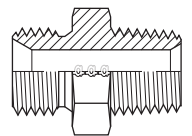

SS9007-02-02	SS9007-08-06	SS9007-16-20
SS9007-02-04	SS9007-08-08	SS9007-20-12
SS9007-04-02	SS9007-08-12	SS9007-20-16
SS9007-04-04	SS9007-10-08	SS9007-20-20
SS9007-04-06	SS9007-12-08	SS9007-20-24
SS9007-06-02	SS9007-12-12	SS9007-24-20
SS9007-06-04	SS9007-12-16	SS9007-24-24
SS9007-06-06	SS9007-16-08	SS9007-32-32
SS9007-06-08	SS9007-16-12	
SS9007-08-04	SS9007-16-16	

# STAINLESS STEEL INTERNATIONAL ADAPTERS

## SS9008

STAINLESS MALE BSPT X MALE NPT NIPPLE

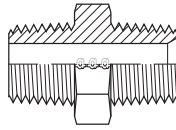

SS9008-04-04	SS9008-08-08	SS9008-16-16
SS9008-06-06	SS9008-12-12	SS9008-20-20

## SS9009

STAINLESS MALE JIC X FEMALE BSP

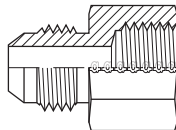

SS9009-04-04	SS9009-08-06	SS9009-16-16
SS9009-06-04	SS9009-08-08	SS9009-20-20
SS9009-06-06	SS9009-10-10	SS9009-24-24
SS9009-06-08	SS9009-12-12	

## SS9010

STAINLESS MALE BSPT NIPPLE

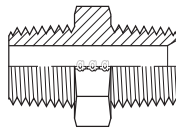

SS9010-02-02	SS9010-08-08	SS9010-24-24
SS9010-04-02	SS9010-12-08	SS9010-32-32
SS9010-04-04	SS9010-12-12	SS9010-40-40
SS9010-06-04	SS9010-16-12	SS9010-48-48
SS9010-06-06	SS9010-16-16	
SS9010-08-06	SS9010-20-20	

## SS9011

STAINLESS MALE JIC X MALE BSPT

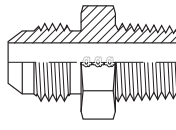

SS9011-04-02	SS9011-08-06	SS9011-12-16
SS9011-04-04	SS9011-08-08	SS9011-16-16
SS9011-06-04	SS9011-08-12	SS9011-16-20
SS9011-06-06	SS9011-10-08	SS9011-20-20
SS9011-06-08	SS9011-12-08	SS9011-24-24
SS9011-08-04	SS9011-12-12	

## SS9015

STAINLESS MALE BSPP X FEMALE BSPP SWIVEL



SS9015-02-02	SS9015-08-04	SS9015-12-16
SS9015-02-04	SS9015-08-06	SS9015-16-12
SS9015-04-02	SS9015-08-08	SS9015-16-16
SS9015-04-04	SS9015-08-12	SS9015-20-20
SS9015-04-06	SS9015-10-08	SS9015-24-24
SS9015-06-04	SS9015-10-10	SS9015-32-32
SS9015-06-06	SS9015-12-08	
SS9015-06-08	SS9015-12-12	

## SS9020

STAINLESS MALE JIC X FEMALE JIC SWIVEL

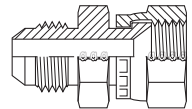

SS9020-04-04	SS9020-08-08	SS9020-12-10
SS9020-04-06	SS9020-08-10	SS9020-12-12
SS9020-06-04	SS9020-08-12	SS9020-16-12
SS9020-06-06	SS9020-10-08	SS9020-16-16
SS9020-06-08	SS9020-10-10	
SS9020-08-06	SS9020-12-08	

## SS9021

STAINLESS MALE BSPP X FEMALE JIC SWIVEL

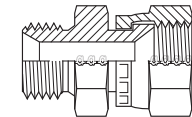

SS9021-04-04	SS9021-12-12
SS9021-06-06	SS9021-16-16
SS9021-08-08	SS9021-20-20
SS9021-10-10	SS9021-24-24

## SS9026

STAINLESS FEMALE JIC (SWIVEL) UNION



SS9026-04-04	SS9026-12-12
SS9026-06-06	SS9026-16-16
SS9026-08-08	SS9026-20-20
SS9026-10-10	SS9026-24-24



# STAINLESS STEEL INTERNATIONAL ADAPTERS

## SS9028

STAINLESS BSPP COUNTERSUNK SEALED PLUG

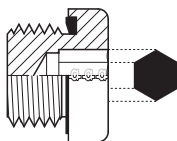

SS9028-02	SS9028-12
SS9028-04	SS9028-16
SS9028-06	SS9028-20
SS9028-08	

## SS9033

STAINLESS FEMALE BSPP CAP

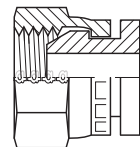

SS9033-02	SS9033-12	SS9033-32
SS9033-04	SS9033-16	
SS9033-06	SS9033-20	
SS9033-08	SS9033-24	

## SS9029

STAINLESS METRIC COUNTERSUNK SEALED PLUG

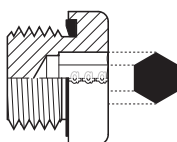

SS9029-10X1.0	SS9029-18X1.5	SS9029-27X2.0
SS9029-12X1.5	SS9029-20X1.5	SS9029-33X2.0
SS9029-14X1.5	SS9029-22X1.5	
SS9029-16X1.5	SS9029-26X1.5	

## SS9035S

STAINLESS MALE BSPP X FEMALE NPT COMES W/ WASHER & O-RING

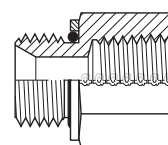

SS9035S-02-02	SS9035S-06-06	SS9035S-16-16
SS9035S-04-02	SS9035S-08-06	SS9035S-20-20
SS9035S-04-04	SS9035S-08-08	SS9035S-24-24
SS9035S-06-04	SS9035S-12-12	SS9035S-32-32

## SS9030

STAINLESS MALE BSPP HEX PLUG

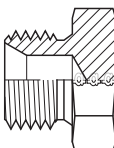

SS9030-02	SS9030-10	SS9030-24
SS9030-04	SS9030-12	SS9030-32
SS9030-06	SS9030-16	
SS9030-08	SS9030-20	

## SS9037

STAINLESS MALE NPT X FEMALE BSP

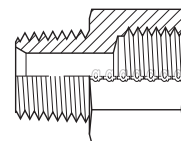

SS9037-02-02	SS9037-06-06	SS9037-20-20
SS9037-02-04	SS9037-08-08	SS9037-24-24
SS9037-04-02	SS9037-12-12	SS9037-32-32
SS9037-04-04	SS9037-16-16	

## SS9030T

STAINLESS BSPT HEX PLUG

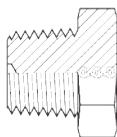

SS9030T-02	SS9030T-12	SS9030T-32
SS9030T-04	SS9030T-16	SS9030T-40
SS9030T-06	SS9030T-20	SS9030T-48
SS9030T-08	SS9030T-24	

## SS9038

STAINLESS MALE BSPP X FEMALE BSP BUSHING

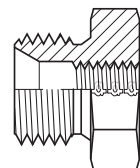

SS9038-06-02	SS9038-12-06	SS9038-32-20
SS9038-08-04	SS9038-16-08	

# STAINLESS STEEL INTERNATIONAL ADAPTERS

## SS9039

STAINLESS MALE BSPP X FEMALE  
BSP EXTENDED BUSHING

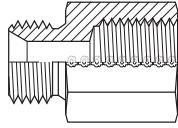

SS9039-02-06	SS9039-06-04	SS9039-08-08
SS9039-04-02	SS9039-06-06	SS9039-12-08
SS9039-04-04	SS9039-06-08	SS9039-12-12
SS9039-04-06	SS9039-08-06	SS9039-16-12

## SS9043

STAINLESS BSP (SOLID) X BSP  
(SOLID) COUPLING

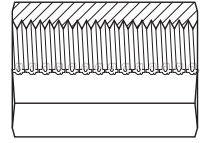

SS9043-02-02	SS9043-12-12	SS9043-32-32
SS9043-04-04	SS9043-16-16	
SS9043-06-06	SS9043-20-20	
SS9043-08-08	SS9043-24-24	

## SS9040

STAINLESS MALE BSPP X MALE  
BSPP BULKHEAD

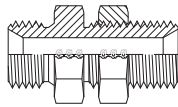

SS9040-02-02	SS9040-10-10	SS9040-24-24
SS9040-04-04	SS9040-12-12	SS9040-32-32
SS9040-06-06	SS9040-16-16	SS9040-40-40
SS9040-08-08	SS9040-20-20	

## SS9056

STAINLESS 90° MALE JIC X  
FEMALE BSPP (SWIVEL) ELBOW

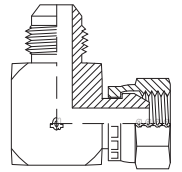

SS9056-04-04	SS9056-08-08	SS9056-16-16
SS9056-06-06	SS9056-12-12	

## SS9041

STAINLESS BSPP BULKHEAD  
LOCKNUT

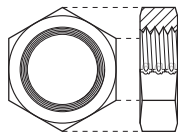

SS9041-02	SS9041-16	SS9041-40
SS9041-04	SS9041-20	
SS9041-08	SS9041-24	
SS9041-12	SS9041-32	

## SS9058

STAINLESS 45° MALE JIC X MALE  
BSPP ADJ. ELBOW

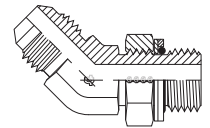

SS9058-04-04	SS9058-08-08	SS9058-16-16
SS9058-06-06	SS9058-12-12	

## SS9042

STAINLESS MALE BSPT X FEMALE  
NPT

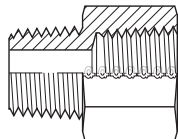

SS9042-02-02	SS9042-12-12
SS9042-04-04	SS9042-16-16
SS9042-06-06	SS9042-20-20
SS9042-08-08	SS9042-24-24

## SS9059

STAINLESS 90° MALE JIC X MALE  
BSPP ADJ. ELBOW

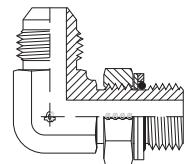

SS9059-04-02	SS9059-06-08	SS9059-12-12
SS9059-04-04	SS9059-08-06	SS9059-16-16
SS9059-06-04	SS9059-08-08	SS9059-20-20
SS9059-06-06	SS9059-12-08	SS9059-24-24

# STAINLESS STEEL INTERNATIONAL ADAPTERS

## SS9063

STAINLESS 90° MALE JIC X MALE BSPT ELBOW

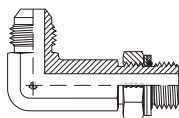

SS9063-04-02	SS9063-08-06
SS9063-04-04	SS9063-08-08
SS9063-06-04	SS9063-10-08
SS9063-06-06	SS9063-12-12

## SS9069

STAINLESS 90° MALE JIC X MALE METRIC ELBOW

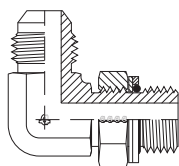

SS9069-04-10	SS9069-06-14	SS9069-08-18
SS9069-04-12	SS9069-06-16	

## SS9200

STAINLESS MALE JIC X DIN STANDPIPE

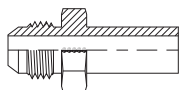

SS9200-04-06	SS9200-08-12	SS9200-12-22
SS9200-04-08	SS9200-08-14	SS9200-12-25
SS9200-04-10	SS9200-08-15	SS9200-16-28
SS9200-06-08	SS9200-08-16	SS9200-16-30
SS9200-06-10	SS9200-12-18	
SS9200-06-12	SS9200-12-20	

## SS9235

STAINLESS MALE METRIC X FEMALE NPT

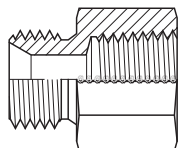

SS9235-10-02	SS9235-18-06
SS9235-10X1.5-02	SS9235-22-08
SS9235-16-06	SS9235-24-12
SS9235-16-08	

## SS9240

STAINLESS MALE JIC X FEMALE BSPP SWIVEL

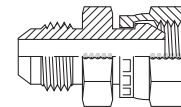

SS9240-04-04	SS9240-08-08	SS9240-16-12
SS9240-06-06	SS9240-12-12	SS9240-16-16

## SS9500

STAINLESS BONDED SEAL FOR BSPP THREAD

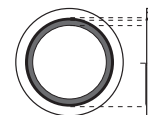

SS9500-02	SS9500-10	SS9500-24
SS9500-04	SS9500-12	SS9500-32
SS9500-06	SS9500-16	
SS9500-08	SS9500-20	

## SS9500-MM

STAINLESS BONDED SEAL FOR METRIC THREAD

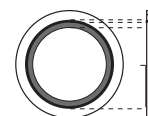

SS9500-06MM	SS9500-14MM	SS9500-22MM
SS9500-08MM	SS9500-16MM	SS9500-26MM
SS9500-10MM	SS9500-18MM	SS9500-30MM
SS9500-12MM	SS9500-20MM	

## SS9500-V

STAINLESS BONDED SEAL FOR BSPP THREAD (VITON)

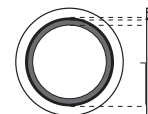

SS9500-02V	SS9500-10V
SS9500-04V	SS9500-12V
SS9500-06V	SS9500-16V
SS9500-08V	

# STAINLESS STEEL INTERNATIONAL ADAPTERS

## SS9500-MMV

STAINLESS BONDED SEAL FOR METRIC THREAD (VITON)

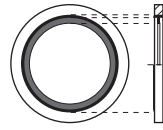

SS9500-10MMV	SS9500-20MMV
SS9500-12MMV	SS9500-24MMV
SS9500-14MMV	SS9500-26MMV
SS9500-16MMV	

## SS9605

STAINLESS MALE JIC X MALE METRIC DIN (LIGHT DUTY)

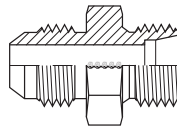

SS9605-04-L06-12	SS9605-10-L15-22
SS9605-04-L08-14	SS9605-12-L18-26
SS9605-06-L10-16	SS9605-12-L22-30
SS9605-06-L12-18	SS9605-16-L28-36
SS9605-08-L12-18	
SS9605-08-L15-22	

## SS9606

STAINLESS MALE JIC X MALE METRIC DIN (HEAVY DUTY)

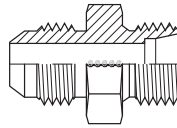

SS9606-04-S06-14	SS9606-08-S16-24
SS9606-04-S08-16	SS9606-10-S16-24
SS9606-06-S10-18	SS9606-12-S20-30
SS9606-06-S12-20	SS9606-12-S25-36
SS9606-08-S10-18	SS9606-16-S30-42
SS9606-08-S12-20	

## SS9900

STAINLESS FEMALE BSPP (SWIVEL) X HOSE BARB



SS9900-04-04	SS9900-08-08	SS9900-16-16
SS9900-06-06	SS9900-12-12	

## SS9915

STAINLESS MALE BSPT X PUSH ON HOSE BARB

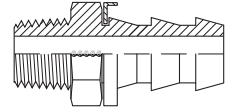

SS9915-04-04	SS9915-12-12
SS9915-06-06	SS9915-16-16
SS9915-06-08	SS9915-20-20
SS9915-08-08	

## SSRR

STAINLESS RETAINING RING BSPP

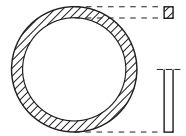

SSRR-02	SSRR-06	SSRR-12
SSRR-04	SSRR-08	SSRR-16

# BRASS COMPRESSION, POLYTUBE & PUSH TO CONNECT

## 166

BRASS COMPRESSION X FEMALE  
BSP

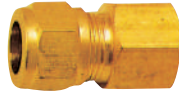

166-04-02	166-06-04
166-04-04	166-06-06
166-05-02	166-08-08
166-05-04	

## 168

BRASS COMPRESSION X MALE  
BSPT



168-04-02	168-05-04	168-06-08
168-04-04	168-06-02	168-08-04
168-04-06	168-06-04	168-08-06
168-05-02	168-06-06	168-08-08

## 169

90° BRASS COMPRESSION X MALE  
BSPT ELBOW



169-04-02	169-05-04	169-08-04
169-04-04	169-06-04	169-08-06
169-04-06	169-06-06	169-08-08
169-05-02	169-06-08	

## 171

BRASS COMPRESSION X MALE  
BSPT RUN TEE



171-04-02	171-06-04
171-04-04	171-06-06
171-05-02	171-08-06
171-05-04	

## 172

BRASS COMPRESSION X MALE  
BSPT BRANCH TEE

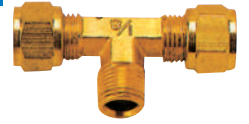

172-04-02	172-06-04
172-04-04	172-06-06
172-05-02	172-08-06
172-05-04	

## 266

BRASS POLYTUBE COMPRESSION  
X FEMALE BSP



266-04-02	266-06-06
266-04-04	266-08-06
266-05-04	
266-06-04	

## 268

BRASS POLYTUBE COMPRESSION  
X MALE BSPT



268-04-02	268-06-02	268-08-08
268-04-04	268-06-04	
268-04-06	268-06-06	
268-05-02	268-06-08	
268-05-04	268-08-04	
268-05-06	268-08-06	

## 269

90° BRASS POLYTUBE  
COMPRESSION X MALE BSPT  
ELBOW



269-04-02	269-05-06	269-08-06
269-04-04	269-06-02	269-08-08
269-04-06	269-06-04	
269-04-08	269-06-06	
269-05-02	269-06-08	
269-05-04	269-08-04	

# BRASS COMPRESSION, POLYTUBE & PUSH TO CONNECT

## 270

90° BRASS POLYTUBE  
COMPRESSION X FEMALE BSP  
ELBOW



270-04-02	270-06-06
270-04-04	270-08-06
270-05-04	
270-06-04	

## 568

BRASS PUSH TO CONNECT X  
MALE BSPT



568-02-02	568-05-04	568-06-08
568-04-04	568-06-02	568-08-04
568-04-06	568-06-04	568-08-06
568-05-02	568-06-06	568-08-08

## 271

BRASS POLYTUBE COMPRESSION  
X MALE BSPT RUN TEE

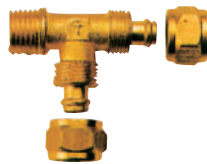

271-04-02	271-06-04
271-04-04	271-06-06
271-05-02	271-08-06
271-05-04	271-08-08

## 569

90° BRASS PUSH TO CONNECT X  
MALE BSPT ELBOW



569-04-02	569-05-06	569-06-08
569-04-04	569-06-02	569-08-04
569-05-02	569-06-04	569-08-06
569-05-04	569-06-06	569-08-08

## 272

BRASS POLYTUBE COMPRESSION  
X MALE BSPT BRANCH TEE

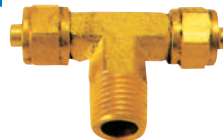

272-04-02	272-05-04	272-08-08
272-04-04	272-06-04	
272-04-06	272-06-06	
272-05-02	272-08-06	

## 569BJ

90° BRASS BANJO PUSH TO  
CONNECT X MALE BSPT ELBOW



569BJ-04-02	569BJ-05-04
569BJ-04-04	569BJ-06-04
569BJ-04-06	569BJ-06-06
569BJ-05-02	

## 566

BRASS PUSH TO CONNECT X  
FEMALE BSPT



566-04-02	566-05-06
566-04-04	566-06-04
566-05-02	566-06-06
566-05-04	566-06-08

## 569L

90° BRASS BANJO PUSH TO  
CONNECT X MALE BSPT ELBOW  
LONG



569L-04-02	569L-06-04
569L-04-04	569L-06-06
569L-05-02	569L-08-06
569L-05-04	

# BRASS COMPRESSION, POLYTUBE & PUSH TO CONNECT

## 571

BRASS PUSH TO CONNECT X  
MALE BSPT RUN TEE



571-04-02

571-06-02

571-04-04

571-06-04

571-05-02

571-06-06

571-05-04

## 582

BRASS PUSH TO CONNECT FLOW  
CONTROL VALVE X MALE BSPT



582-04-02

582-06-02

582-04-04

582-06-04

582-05-02

582-06-06

582-05-04

## 572

BRASS PUSH TO CONNECT X  
MALE BSPT BRANCH TEE



572-04-02

572-06-04

572-08-08

572-04-04

572-06-06

572-05-02

572-08-04

572-05-04

572-08-06

## 575

BRASS PUSH TO CONNECT X  
MALE BSPT BRANCH "Y"



575-04-02

575-05-02

575-06-04

575-04-04

575-05-04

575-06-06

## 581

90° BRASS PUSH TO CONNECT  
METERING IN VALVE X MALE BSPT



581-04-02

581-06-02

581-04-04

581-06-04

581-05-02

581-06-06

581-05-04

# BRASS FITTINGS & ADAPTERS

## 8000

BRASS MALE BSPP NIPPLE

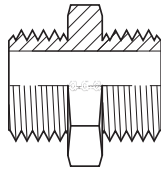

8000-02-02	8000-08-04	8000-16-16
8000-04-02	8000-08-06	8000-24-20
8000-04-04	8000-08-08	
8000-06-02	8000-12-08	
8000-06-04	8000-12-12	
8000-06-06	8000-16-12	

## 8007

BRASS MALE BSPP X MALE NPT

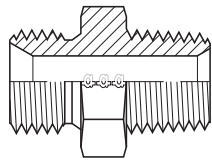

8007-04-04	8007-06-06	8007-32-32
8007-06-04	8007-08-08	

## 8008

BRASS MALE BSPT X MALE NPT

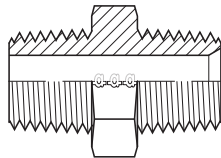

8008-02-02	8008-08-08
8008-02-04	8008-12-12
8008-04-04	8008-16-16
8008-06-06	

## 8010

BRASS MALE BSPT NIPPLE

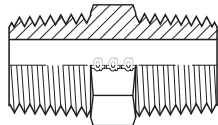

8010-02-02	8010-08-04	8010-16-12
8010-04-02	8010-08-06	8010-16-16
8010-04-04	8010-08-08	
8010-06-02	8010-12-06	
8010-06-04	8010-12-08	
8010-06-06	8010-12-12	

## 8011

BRASS MALE JIC X MALE BSPT

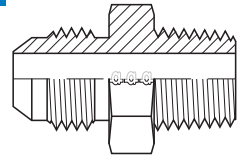

8011-04-02	8011-06-06	8011-12-12
8011-04-04	8011-08-06	

## 8028

BRASS BSPP SEALED ALLEN KEY PLUG

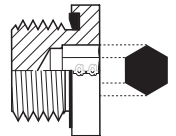

8028-02	8028-06
8028-04	8028-08

## 8030CSP

BRASS COUNTERSUNK BSPT PLUG

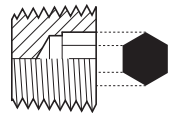

8030CSP-02	8030CSP-06	8030CSP-12
8030CSP-04	8030CSP-08	8030CSP-16

## 8033

BRASS FEMALE BSP CAP

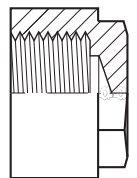

8033-02	8033-06	8033-12
8033-04	8033-08	

## 8035

BRASS MALE BSPP X FEMALE NPT

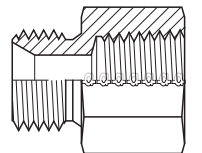

8035-02-02	8035-06-06	8035-20-20
8035-04-02	8035-08-08	
8035-04-04	8035-12-12	
8035-04-06	8035-16-16	



# BRASS FITTINGS & ADAPTERS

## 8036

BRASS MALE BSPT X FEMALE NPT

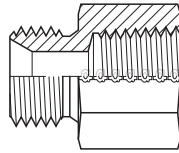

8036-02-02	8036-12-12
8036-04-04	8036-16-08
8036-06-06	8036-16-16
8036-08-08	

## 8037

BRASS MALE NPT X FEMALE BSP

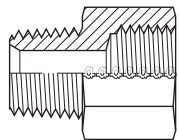

8037-02-02	8037-06-06	8037-12-12
8037-04-04	8037-08-08	

## 8037T

BRASS MALE NPT X FEMALE BSPT

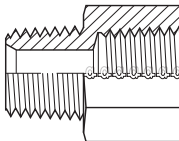

8037T-02-02	8037T-08-12
8037T-04-04	8037T-12-12
8037T-06-06	8037T-16-16
8037T-08-08	8037T-20-20

## 8038

BRASS MALE BSPT X FEMALE BSP

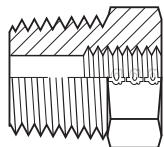

8038-02-02	8038-04-08	8038-12-06
8038-02-04	8038-06-02	8038-12-08
8038-02-06	8038-06-04	8038-16-12
8038-04-02	8038-06-06	
8038-04-04	8038-08-04	
8038-04-06	8038-08-06	

## 8039

BRASS MALE BSPP X FEMALE BSP BUSHING

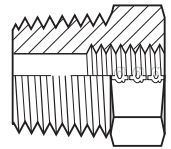

8039-02-02	8039-06-04	8039-08-08
8039-02-04	8039-06-06	8039-12-04
8039-04-02	8039-06-08	8039-12-06
8039-04-04	8039-08-02	8039-12-08
8039-04-06	8039-08-04	8039-16-12
8039-06-02	8039-08-06	

## 8043

BRASS FEMALE BSP COUPLING

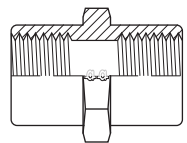

8043-02-02	8043-06-04	8043-08-08
8043-04-02	8043-06-06	8043-12-12
8043-04-04	8043-08-04	8043-32-32
8043-06-02	8043-08-06	

## 8044

BRASS FEMALE BSP X FEMALE NPT

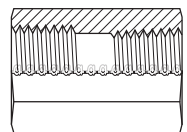

8044-02-02	8044-08-04	8044-24-24
8044-04-04	8044-08-08	8044-32-32
8044-06-04	8044-16-16	8044-48-40
8044-06-06	8044-20-20	

## 8055

BRASS 90° MALE BSPT ELBOW

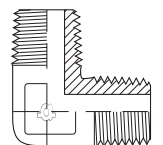

8055-02-02	8055-06-06	8055-12-12
8055-04-04	8055-08-08	

# BRASS FITTINGS & ADAPTERS

## 8060

BRASS 90° MALE BSPT X FEMALE BSP

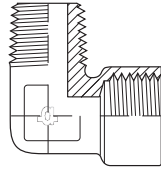

8060-02-02  
8060-04-04

8060-06-06  
8060-08-08

8060-12-12

## 8095

BRASS FEMALE BSP X MALE BSPT RUN TEE

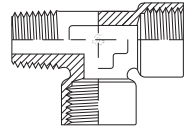

8095-02-02-02  
8095-04-04-04

8095-06-06-06  
8095-08-08-08

## 8075

BRASS 90° FEMALE BSP ELBOW

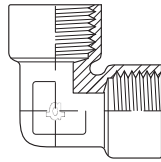

8075-02-02  
8075-04-04

8075-06-06  
8075-08-08

8075-12-12

## 8097

BRASS FEMALE BSP CROSS

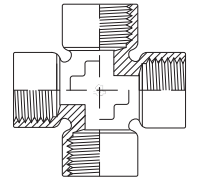

8097-02-02-02-02  
8097-04-04-04-04

8097-06-06-06-06  
8097-08-08-08-08

## 8080

BRASS MALE BSPT TEE

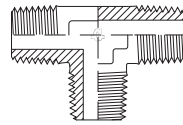

8080-02-02-02  
8080-04-04-04

8080-06-06-06  
8080-08-08-08

8080-12-12-12

## 8235

BRASS MALE METRIC X FEMALE NPT

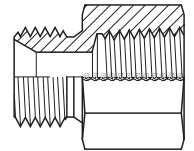

8235-14-02  
8235-14-04

8235-16-06  
8235-18-08

8235-22-06

## 8085

BRASS FEMALE BSP TEE

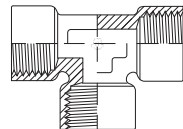

8085-02-02-02  
8085-04-04-04

8085-06-06-06  
8085-08-08-08

8085-12-12-12

## 8900

BRASS FEMALE BSPP (SWIVEL) X HOSE BARB

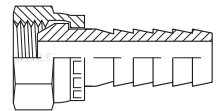

8900-04-04  
8900-06-06

8900-06-08  
8900-08-08

8900-12-12

## 8093

BRASS FEMALE BSP X MALE BSPT BRANCH TEE

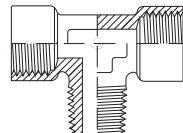

8093-02-02-02  
8093-04-04-04

8093-06-06-06  
8093-08-08-08

## 8920

BRASS MALE BSPP X HOSE BARB

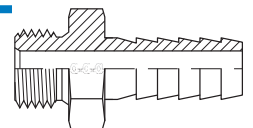

8920-04-06  
8920-04-08

8920-08-08  
8920-12-12

8920-16-16

## 8920T

MALE BSPT X HOSE BARB

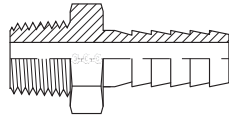

8920T-02-02	8920T-04-08	8920T-12-12
8920T-02-03	8920T-06-04	8920T-16-16
8920T-02-04	8920T-06-06	8920T-20-20
8920T-02-05	8920T-06-08	8920T-24-24
8920T-02-06	8920T-08-06	8920T-32-32
8920T-04-03	8920T-08-08	
8920T-04-04	8920T-08-12	
8920T-04-06	8920T-12-08	

# BSP BLACK PIPE/MALLEABLE IRON

## B14C

BLACK BSP CAP

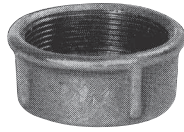

B14C-04	B14C-16	B14C-40
B14C-06	B14C-20	B14C-48
B14C-08	B14C-24	
B14C-12	B14C-32	

## B1404

BLACK BSP COUPLING



B1404-04-04	B1404-16-16	B1404-32-24
B1404-06-04	B1404-20-16	B1404-32-32
B1404-06-06	B1404-20-20	B1404-40-32
B1404-08-04	B1404-24-08	B1404-40-40
B1404-08-06	B1404-24-20	B1404-48-40
B1404-08-08	B1404-24-24	B1404-48-48
B1404-12-08	B1404-32-08	
B1404-12-12	B1404-32-12	
B1404-16-08	B1404-32-16	
B1404-16-12	B1404-32-20	

## B1404U

BLACK BSP UNION

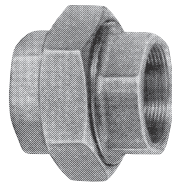

B1404U-02-02	B1404U-12-12	B1404U-32-32
B1404U-04-04	B1404U-16-16	B1404U-40-40
B1404U-06-06	B1404U-20-20	B1404U-48-48
B1404U-08-08	B1404U-24-24	

## B1804

BLACK BSPT BUSHING



B1804-04-02	B1804-16-08	B1804-32-20
B1804-06-02	B1804-16-12	B1804-32-24
B1804-06-04	B1804-20-08	B1804-40-20
B1804-08-02	B1804-20-12	B1804-40-24
B1804-08-04	B1804-20-16	B1804-40-32
B1804-08-06	B1804-24-08	B1804-48-24
B1804-12-04	B1804-24-12	B1804-48-32
B1804-12-06	B1804-24-16	B1804-48-40
B1804-12-08	B1804-24-20	
B1804-16-06	B1804-32-16	

## B1808H

BLACK HEXAGON BSPT NIPPLE

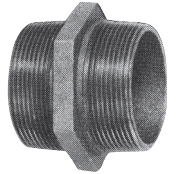

B1808H-04-02	B1808H-12-12	B1808H-32-20
B1808H-04-04	B1808H-16-08	B1808H-32-24
B1808H-06-02	B1808H-16-12	B1808H-32-32
B1808H-06-04	B1808H-16-16	B1808H-40-32
B1808H-06-06	B1808H-20-12	B1808H-40-40
B1808H-08-04	B1808H-20-16	B1808H-48-48
B1808H-08-06	B1808H-20-20	B1804-48-32
B1808H-08-08	B1808H-24-16	B1804-48-40
B1808H-12-06	B1808H-24-20	
B1808H-12-08	B1808H-24-24	

## B1808L

BLACK LONG BSPT NIPPLE



B1808L-04-40MM	B1808L-12-40MM
B1808L-04-60MM	B1808L-12-60MM
B1808L-04-80MM	B1808L-12-80MM
B1808L-04-120MM	B1808L-16-40MM
B1808L-06-40MM	B1808L-16-60MM
B1808L-06-60MM	B1808L-16-80MM
B1808L-06-80MM	B1808L-20-150MM
B1808L-08-40MM	B1808L-20-400MM
B1808L-08-60MM	B1808L-20-4"
B1808L-08-80MM	B1808L-20-10"

# BSP BLACK PIPE/MALLEABLE IRON

## B18SQP

BLACK BSPT SQUARE HEAD PLUG

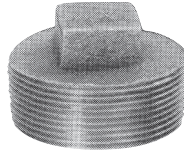

B18SQP-04	B18SQP-16	B18SQP-40
B18SQP-06	B18SQP-20	B18SQP-48
B18SQP-08	B18SQP-24	
B18SQP-12	B18SQP-32	

## B2404

BLACK BSP 45° FEMALE ELBOW

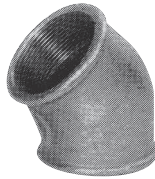

B2404-06-06	B2404-20-20
B2404-08-08	B2404-24-24
B2404-12-12	B2404-32-32
B2404-16-16	

## B2804

BLACK 45° BSPT STREET ELBOW

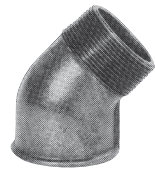

B2804-06-06	B2804-12-12	B2804-20-20
B2804-08-08	B2804-16-16	

## B3404

BLACK BSP 90° FEMALE ELBOW

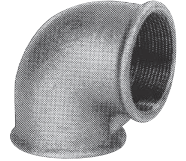

B3404-02-02	B3404-12-08	B3404-24-16
B3404-04-04	B3404-12-12	B3404-24-20
B3404-06-04	B3404-16-08	B3404-24-24
B3404-06-06	B3404-16-12	B3404-32-32
B3404-08-04	B3404-16-16	B3404-40-40
B3404-08-06	B3404-20-12	B3404-48-48
B3404-08-08	B3404-20-16	
B3404-12-06	B3404-20-20	

## B3804

BLACK 90° BSPT STREET ELBOW

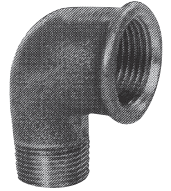

B3804-04-04	B3804-16-16	B3804-40-40
B3804-06-06	B3804-20-20	B3804-48-48
B3804-08-08	B3804-24-24	
B3804-12-12	B3804-32-32	

## B4444

BLACK BSP FEMALE TEE

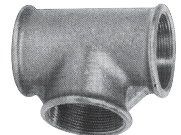

B4444-04	B4444-24	B4444-48
B4444-06	B4444-24-08-20	
B4444-08	B4444-24-20-24	
B4444-12	B4444-32	
B4444-16	B4444-32-32-08	
B4444-20	B4444-40	



Adaptall was founded in 1985 with the intent to supply the North American hose and fitting distributor market with high quality Metric and British adapters, in steel, stainless steel and brass.

We have grown to include multiple locations in Canada and the USA, including a CNC manufacturing facility, in order to meet the many unique needs of our valued customers.

We pride ourselves on providing industry leading customer service and the largest inventory of Metric and British Adapters in North America.

#### TERMS & CONDITIONS

- Prices subject to change without prior notice.
- F.O.B. our plant.
- All taxes and government surcharges are extra where applicable.
- No returns without prior written consent (see Returns Policy).
- All sales to U.S. customers are payable in USD funds.
- All sales to Canadian customers are payable in CAD funds.
- All sales to International customers are payable in USD funds.

#### WARRANTY

Adaptall warrants its products to be free of defects in material and workmanship. No warranty of merchantability or other warranty, express or implied, is made. Liability for and the exclusive remedy for defective materials or workmanship is limited to replacement or repair of defective products returned within 60 days after receipt. No allowance will be made for repairs performed by the purchaser or on their order. Adaptall is not liable for consequential or other damages or any expense incurred through the use of its products. All design and dimensional data are subject to change without notice. Working pressures, torque settings, corrosion data and other technical information have been prepared from actual test results and other data considered to be reliable. However, no responsibility can be assumed for the accuracy of this information under varied field conditions and should be considered as a recommendation only and not a guarantee.

#### COMPLIANCES

- ISO 9001:2015
- C-TPAT & PIP
- Buy America Act / American Reinvestment and Recovery Act of 2009 (ARRA)
- Proposition 65 (California)

#### FITTING STANDARDS

- BSPP (ISO 1179-1, 1179-2, 1179-3, 8434-6)
- BSPT (ISO 7-1)
- DIN TUBE (DIN 2353, DIN 3861, ISO 8434-1)
- JIC (ISO 8434-2)
- METRIC (DIN 7647, ISO 6149, 9974-1, 9974-2, 9974-4)
- NPT (ANSI B1.20.3)
- ORB (ISO 11926, SAE J1926)
- ORFS (ISO 8434-3)

#### ZINC PLATING SPECIFICATIONS (STEEL PARTS)

- Plating shall be in accordance with ASTM B633-15
- Listed as Type Fe/Zn 8 Class V with clear coat
- Electro-Deposited Zinc coating with minimum thickness of 8 microns (0.0003")
- Compliant: OSHA (USA), CCOHS (Canada) and RoHS (European Union)
- Zinc coating does NOT contain hexavalent chromate

#### MATERIAL SPECIFICATIONS

##### Brass

- North American products: C36000
- European products: OT UNI EN 12164/5 CW 614/7N

##### Carbon steel

- European & North American products: C12L14
- Asian products: GB/T 699-2015

##### Stainless steel

- SS DIN tube fittings: SS316Ti
- Standard SS fittings: SS316

##### O-rings

- Nitrile (NBR) 70-90 durometer
- Viton 75-90 durometer

# TORQUE SPECIFICATION CHARTS

## BSPP Port – Torque Settings

	Dash Size	Inch Thread Size-TPI	Retaining Ring & O-Ring		ED/ES Seal		Bonded Washer	Cutting Face	Banjo	
			Straight (Nm)	Adjustable (Nm)	Straight (Nm)	Plugs (Nm)	Straight (Nm)	Straight (Nm)	With Internal Seals	Without Internal Seals
Light Series (L)	02	1/8-28	18	18	18	13	9	18	18	18
	04	¼-19	35	35	35	30	35	35	45	40
	06	3/8-19	70	70	70	60	45	70	70	65
	08	½-14	90	110	90	80	65	100	120	90
	12	¾-14	180	180	180	140	90	180	230	125
	16	1-11.5	310	310	310	200	150	330	320	
	20	1-1/4-11.5	450	450	450	400	240	540	540	
	24	1-1/2-11.5	540	540	540	450	290	630	700	
Heavy Series (S)	02	1/8-28		25						
	04	¼-19		55	40		35	55	45	
	06	3/8-19		90	80		45	90	70	
	08	½-14		110	115		65	130	120	
	12	¾-14		115	180		90	270	230	
	16	1-11.5		420	310		150	340	320	
	20	1-1/4-11.5		550	450		240	540	540	
	24	1-1/2-11.5		600	540		290	700	700	

## Metric Port – Torque Settings

	Thread Size Mm	Retaining Ring & O-Ring		ED/ES Seal		ISO 6149	Bonded Washer	Cutting Face	Banjo	
		Straight (Nm)	Adjustable (Nm)	Straight (Nm)	Plugs (Nm)	Straight & Adjustable (Nm)	Straight (Nm)	Straight (Nm)	With Internal Seals	Without Internal Seals
Light Series (L)	12	35	35	30	25	25	20	30	45	35
	14	45	45	50	35	35	35	45	55	50
	16	55	55	60	50	40	45	65	80	60
	18	70	70	80	65	45	55	80	100	80
	22	160	180	140	90	60	65	140	140	120
	26	250	180	200	135		90	190	320	130
	27					100				
	33	310	310	380	225	160	150	340	360	
	42	450	450	500	360	210	240	500	540	
	48	540	600	600	360	260	290	630	700	
Heavy Series (S)	12		35	45		35	20	35	45	35
	14		60	60		45	35	55	55	50
	16		95	80		55	45	70	80	60
	18		120	100		70	55	110	100	80
	20			140		80	55	150	125	110
	22		190	150		100	65	170	135	120
	27		190	200		170	90	270	320	135
	33		500	380		310	150	410	360	
	42		600	500		330	240	540	540	
	48		600	600		420	290	700	700	

## DIN DKO Swivel - Torque Settings

	Thread Size Mm	Tube Size	DIN DKO Swivel (Nm)
L Light Duty	12	L06	16
	14	L08	16
	16	L10	26
	18	L12	37
	22	L15	47
	26	L18	89
	30	L22	116
	36	L28	137
	45	L35	226
	52	L42	347
S Heavy Duty	14	S06	26
	16	S08	42
	18	S10	53
	20	S12	63
	22	S14	79
	24	S16	84
	30	S20	126
	36	S25	179
	42	S30	263
	52	S38	368

## BSPP Swivel - Torque Settings

Dash Thread Size	Inch Thread Size-Tpi	BSPP Swivel (Nm)
02	1/8-18	
04	1/4-19	20
06	3/8-19	35
08	1/2-14	60
10	5/8-14	70
12	3/4-14	115
16	1-11.5	140
20	1-1/4-11.5	210
24	1-1/2-11.5	290
52	L42	347

## BSPT T.F.F.T Values

BSPT Dash Size	Inch Thread Size-TPI	Turns From Finger Tight (T.F.F.T)
02	1/8-18	2 – 3
04	¼-19	2 – 3
06	3/8-19	2 – 3
08	½-14	2 – 3
10	5/8-14	2 – 3
12	¾-14	2-3
16	1-11.5	1.5 – 2.5
20	1-1/4-11.5	1.5 – 2.5
24	1-1/2-11.5	1.5 – 2.5



ISO 9001  
REGISTERED

PIP  
PARTNERS IN PROTECTION



 1-800-463-8134

 1-800-994-5699

 SALES@ADAPTALL.COM

 WWW.ADAPTALL.COM

 LINKEDIN.COM/COMPANY/ADAPTALL

 @ADAPTALL



**HOUSTON DC**  
5246 N SAM HOUSTON PKWY E  
HOUSTON, TX  
77032

**USA HQ & DC**  
9047 DUTTON DR.  
TWINSBURG, OH  
44087

**CANADA HQ & DC**  
150 BRUNEL RD.  
MISSISSAUGA, ON  
L4Z 1T5

**MANUFACTURING**  
1050 SALK RD.  
PICKERING, ON  
L1W 3C5